

Panduit Network Core and Data Center Physical Infrastructure Reference Guide

● ● ● SMART BUSINESS ARCHITECTURE

August 2012 Series

Preface

Who Should Read This Guide

This Cisco® Smart Business Architecture (SBA) guide is for people who fill a variety of roles:

- Systems engineers who need standard procedures for implementing solutions
- Project managers who create statements of work for Cisco SBA implementations
- Sales partners who sell new technology or who create implementation documentation
- Trainers who need material for classroom instruction or on-the-job training

In general, you can also use Cisco SBA guides to improve consistency among engineers and deployments, as well as to improve scoping and costing of deployment jobs.

Release Series

Cisco strives to update and enhance SBA guides on a regular basis. As we develop a series of SBA guides, we test them together, as a complete system. To ensure the mutual compatibility of designs in Cisco SBA guides, you should use guides that belong to the same series.

The Release Notes for a series provides a summary of additions and changes made in the series.

All Cisco SBA guides include the series name on the cover and at the bottom left of each page. We name the series for the month and year that we release them, as follows:

month year Series

For example, the series of guides that we released in August 2012 are the “August 2012 Series”.

You can find the most recent series of SBA guides at the following sites:

Customer access: <http://www.cisco.com/go/sba>

Partner access: <http://www.cisco.com/go/sbachannel>

How to Read Commands

Many Cisco SBA guides provide specific details about how to configure Cisco network devices that run Cisco IOS, Cisco NX-OS, or other operating systems that you configure at a command-line interface (CLI). This section describes the conventions used to specify commands that you must enter.

Commands to enter at a CLI appear as follows:

```
configure terminal
```

Commands that specify a value for a variable appear as follows:

```
ntp server 10.10.48.17
```

Commands with variables that you must define appear as follows:

```
class-map [highest class name]
```

Commands shown in an interactive example, such as a script or when the command prompt is included, appear as follows:

```
Router# enable
```

Long commands that line wrap are underlined. Enter them as one command:

```
wrr-queue random-detect max-threshold 1 100 100 100 100 100 100 100
```

Noteworthy parts of system output or device configuration files appear highlighted, as follows:

```
interface Vlan64  
ip address 10.5.204.5 255.255.255.0
```

Comments and Questions

If you would like to comment on a guide or ask questions, please use the [SBA feedback form](#).

If you would like to be notified when new comments are posted, an RSS feed is available from the SBA customer and partner pages.

Table of Contents

| | | | |
|---|----|---|----|
| What's In This SBA Guide | 1 | Conclusion | 24 |
| Cisco SBA Borderless Networks..... | 1 | Appendix A: Sample Bill of Materials | 25 |
| Route to Success | 1 | About Panduit | 27 |
| About This Guide | 1 | | |
| Panduit Business Overview | 2 | | |
| Panduit Technical Overview | 3 | | |
| Design State One—Cisco SBA Network Core | 3 | | |
| Design State Two—Cisco SBA Data Center..... | 15 | | |

What's In This SBA Guide

Cisco SBA Borderless Networks

Cisco SBA helps you design and quickly deploy a full-service business network. A Cisco SBA deployment is prescriptive, out-of-the-box, scalable, and flexible.

Cisco SBA incorporates LAN, WAN, wireless, security, data center, application optimization, and unified communication technologies—tested together as a complete system. This component-level approach simplifies system integration of multiple technologies, allowing you to select solutions that solve your organization's problems—without worrying about the technical complexity.

Cisco SBA Borderless Networks is a comprehensive network design targeted at organizations with up to 10,000 connected users. The SBA Borderless Network architecture incorporates wired and wireless local area network (LAN) access, wide-area network (WAN) connectivity, WAN application optimization, and Internet edge security infrastructure.

Route to Success

To ensure your success when implementing the designs in this guide, you should first read any guides that this guide depends upon—shown to the left of this guide on the route below. As you read this guide, specific prerequisites are cited where they are applicable.

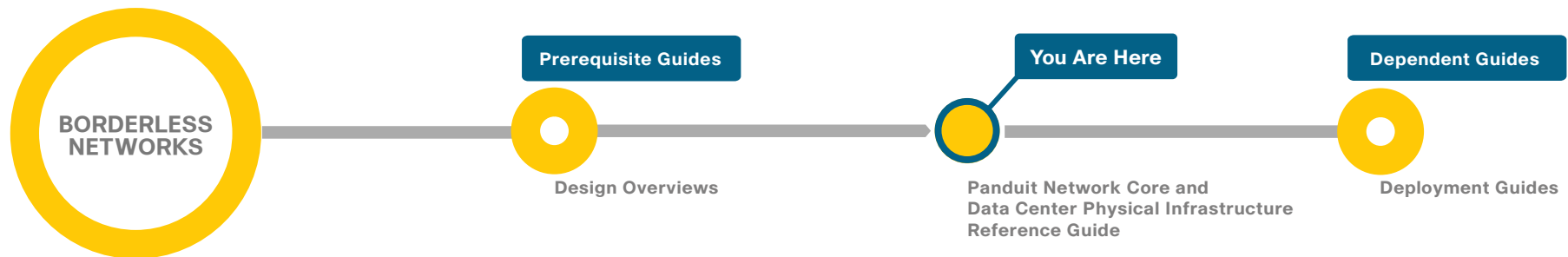

About This Guide

This *ecosystem partner guide* presents solutions, products, or services—provided by a Cisco SBA ecosystem partner—that are compatible with and complementary to SBA.

You can find the most recent series of Cisco SBA guides at the following sites:

Customer access: <http://www.cisco.com/go/sba>

Partner access: <http://www.cisco.com/go/sbachannel>

Panduit Business Overview

Mission-critical applications and reliable, real-time data drive the modern business. The data center has become a centralized information-processing resource, capable of empowering executive stakeholders to make meaningful decisions at the right time. In addition, IT departments are expected to contain costs while ensuring greater reliability and performance from their networks. They must adapt their workload and environment to accommodate a broad array of rapidly changing demands, including:

- Application agility that allows ease of flexibility, scalability, and interoperability of software platforms or technologies to meet current and future business needs.
- Compliance to regulatory demands around documentation, energy management, policies, and more.
- Disaster recovery plans in the event of a catastrophic event.
- Limited space, power, and cooling available for necessary operation and/or expansion.
- Multiple offices or locations located locally, regionally, nationally and/or globally.
- Security against unauthorized access or attacks.

Addressing these issues creates opportunities for IT enterprises to utilize their technology assets to increase revenue by:

- Driving process efficiencies across project lifecycles, thereby enabling stakeholders to realize improved operational benefits, such as lower total cost of ownership (TCO) and optimized facility management.
- Increasing collaboration between employees to create a more dynamic and responsive work force.
- Increasing labor efficiencies by optimizing staffing and enhancing worker productivity, thereby aggregating network requirements and reducing time to install.

The Panduit Smart Data Center solution is one of three application solutions that form the foundation of Panduit's Unified Physical InfrastructureSM (UPI) approach. Panduit's end-to-end UPI solutions reach across information technology, manufacturing operations, and management systems to connect, manage, and automate all critical systems, including communication, computing, control, power, and security. Employing the UPI approach increases business agility and sustainability, while lowering risk and cost.

This guide offers direction to organizations that are designing all aspects of the physical infrastructure of Cisco Smart Business Architecture (SBA), including:

- Green data cabinets and racks.
- Overhead pathways.
- Copper and fiber optic cabling.
- Cable routing and management.
- Power distribution and cooling.
- Grounding and bonding.
- Identification.

Panduit Technical Overview

This guide presents the mapping between the Panduit Smart Data Center physical infrastructure solutions and the logical layer architectures related to the network core design found in the *Cisco SBA—Borderless Networks LAN Deployment Guide*, *Cisco SBA—Borderless Networks WAN deployment guides*, *Cisco SBA—Data Center Server Room Deployment Guide*, and the *Cisco SBA—Data Center Deployment Guide*. By considering the logical and physical layers in a holistic manner, this design delivers on the following principles:

- **Ease of use**—A top requirement was to develop a design that could be deployed with the minimal amount of configuration and day-two management.
- **Cost-effectiveness**—A critical requirement in the selection of products was to match the design guidelines in the Cisco SBA deployment guides, in order to provide an appropriately-sized infrastructure design.
- **Flexibility and scalability**—Products were selected to have the ability to grow or to be repurposed within the architecture, because as the company grows, so too must its infrastructure.
- **Reusability**—The goal, when possible, was to reuse the same products throughout the various modules to minimize the number of products required for spares.

Two design states are examined in this guide. Design state one focuses on the Cisco SBA network core, including LAN and WAN aggregation, server room, and security components. Design state two focuses on the Cisco SBA Data Center. In addition to creating modular and optimized physical infrastructures for these design states today, you must ensure a smooth transition between states tomorrow. This means that very little business disruption or redesign costs are necessary to logically and physically migrate from a network core, with an associated server room for a smaller location, to local data center architecture. However, it is also possible for IT stakeholders to adopt the local data center architecture on day one and achieve a high level of agility, availability, and security. In this guide, Panduit provides clear guidance on how to use a modular and organized approach for implementing both design states, and shows how you can effectively and efficiently manage the infrastructure.

Design State One—Cisco SBA Network Core

Top-Down Room View

Figure 1 illustrates how the network architecture baseline of the Cisco SBA network core maps to physical elements on premises. The room designated for this installation should measure approximately 11 ft. × 13 ft. (3.35 m × 3.96 m) totaling 143 ft² (13 m²). This footprint recommendation is based on the Telecommunications Industry Association (TIA) 569-B standardized descriptions of a common equipment room (CER) or common telecommunications room (CTR) in a typical multi-tenant building space.

One Panduit® Net-Serv® Cabinet labeled C1 and one Panduit® 4 Post Rack System labeled R1 reside at the left-center of the room and provide housing for IT devices in all Foundation modules. One Liebert® CRV™ Row-based Cooling unit (20kW), labeled M1, is also placed next to the rack to provide adequate cooling for all equipment. In addition, two types of overhead pathways exist for proper routing and termination of telecommunications and grounding cables. Finally, adequate free space exists for unobstructed access to equipment during routine maintenance and for proper airflow.

Figure 1 - Top-down view of Cisco SBA network core CER or CTR mapped to logical architecture

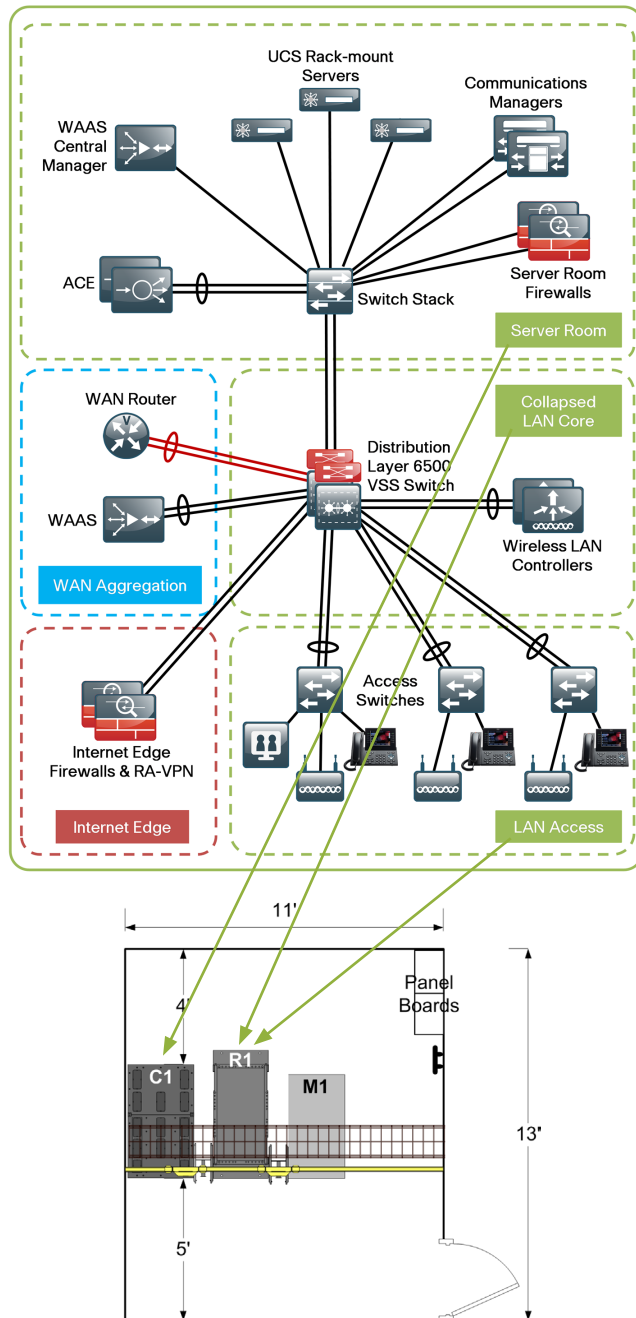

The Net-Serv® Cabinet, C1, contains the server room elements of the campus module and the servers indicated in the application acceleration module. This cabinet also includes all of the existing servers owned by the organization that is adopting the design, the hosts providing the capabilities in the Cisco Unified Communications module, and the server farm switches. The 4-post rack, R1, contains the resilient core/distribution and client access switches, along with the network appliances that provide functionality in the WAN, application optimization, wireless, and security modules. Cabling, cable managers, patch panels, grounding kits, and power outlet units (POU) are interspersed with the IT equipment to provide the physical infrastructure capabilities detailed throughout this guide.

Rack Elevations

Figure 2 shows a rack elevation of the front of the cabinet and rack. Both structures reside on a concrete slab floor. As mentioned in TIA-569-B, a suspended ceiling is not provided within a typical CER or CTR. Because the height of the cabinet, rack, and two tiers of overhead cabling pathways is in excess of 9.5 ft. (2.6 m), the total room height should be a minimum of 11 ft. (3.4 m) off the slab floor to allow the proper amount of buffer space between the physical infrastructure elements and the building spaces.

Figure 2 - Front view of rack elevation of the Cisco SBA foundation module

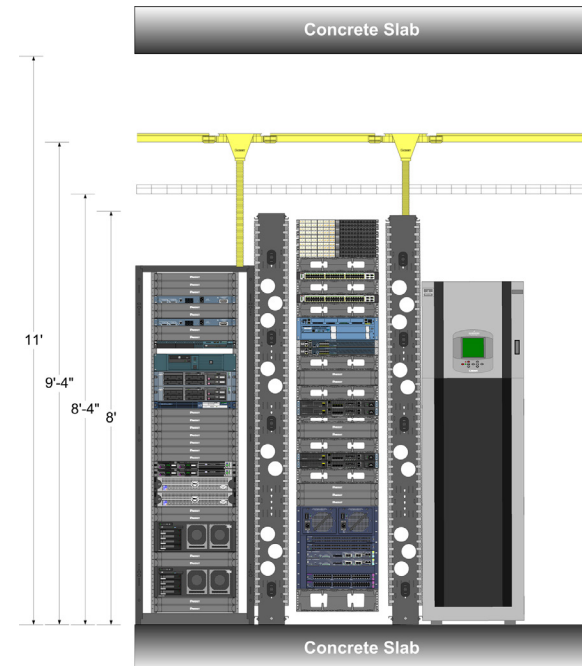

The cabinet and rack involved in this design both have the same standardized elements. Approved IT equipment in the Cisco SBA deployment guides are arranged within the cabinet and rack with the following priorities in mind:

- **Placement**—Whenever possible, devices with the greatest weight, depth, and airflow, measured in cubic feet per minute (CFM), are placed toward the bottom of the cabinet. This allows for the greatest stability and optimal airflow.
- **Airflow**—Some devices, especially network appliances in the security module, have opposing airflow characteristics. These devices are all mounted in the 4-post open rack, which allows for greatest cooling optimization.
- **Layout**—The logical architecture also drives the physical layout. For example, the Cisco Adaptive Security Appliance (ASA) 5525-X and Cisco Intrusion Prevention System (IPS) 4345 appliance from the security module are placed in close proximity in R1 because of their logical interrelationship.
- **Future growth**—Blanking panels are used heavily to reserve space around devices for future hardware upgrades that require larger form factors, and for completely new devices that could be introduced into the design.

Figure 3 illustrates the rack elevation from the rear view. In this depiction, the elements are labeled and mapped from the logical architecture. The figure also displays the two tiers of cabling pathways that are mounted above the structures. According to the TIA-942 Standard, it is important to keep copper and fiber-optic cabling separated to improve administration, operation, and minimize damage to smaller diameter fiber cables. In this design, the Panduit® Wyr-Grid™ Cable Tray System is used to route copper cabling and the Panduit® FiberRunner® Pathway System is used to route fiber-optic cabling.

Figure 3 - Rear view of rack elevation of the Cisco SBA foundation module

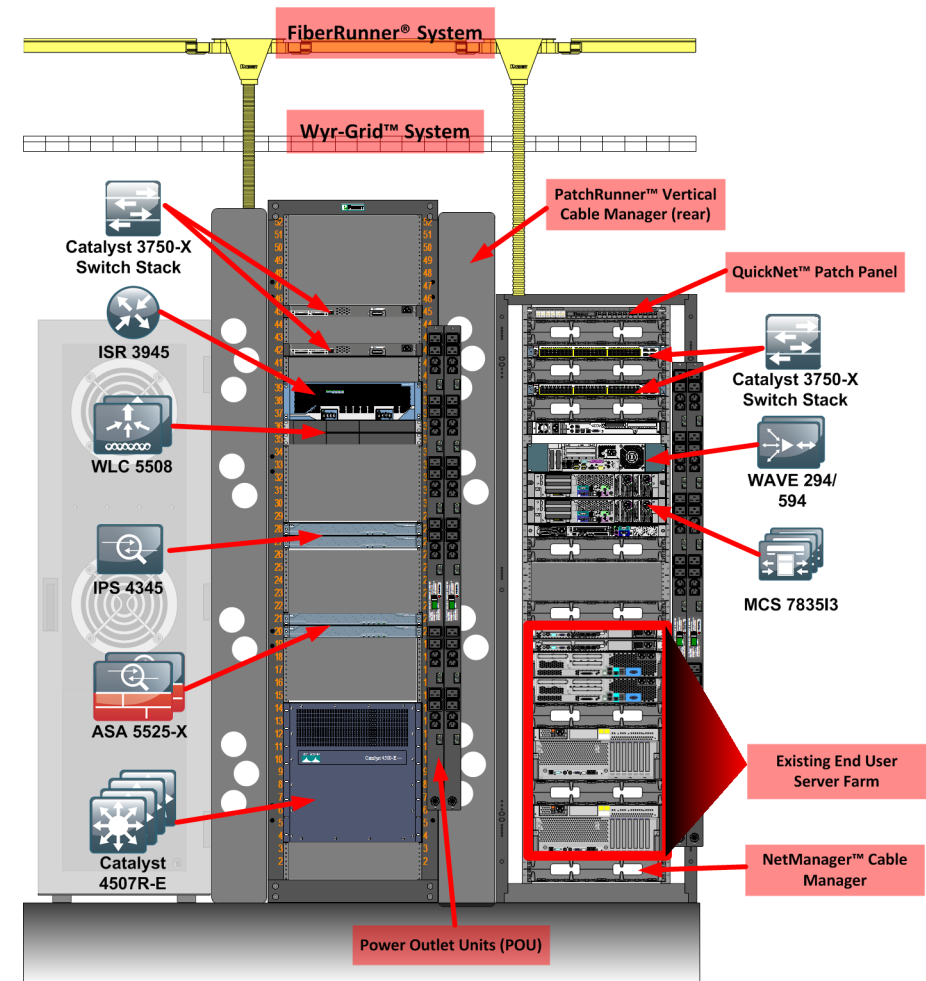

There are two layout options available with this design. The first is to use a modular switch, such as the Catalyst 4507R+E or a pair of Catalyst 6504-E running Virtual Switching to provide more capacity in the network core. The layout of the rack in this situation depicts the Catalyst 4507R+E scenario.

The alternate option, as illustrated in Figure 4, is the layout if a Catalyst 3750-X stack configured with Cisco StackWise+ technology is used. The fixed switches are placed in the same rack units as those consumed by the chassis-based switch. This is done in case business growth demands migration to the Catalyst 4507R+E in the future.

Figure 4 - Rack R1 optional device arrangement using Catalyst 3750-X resilient core

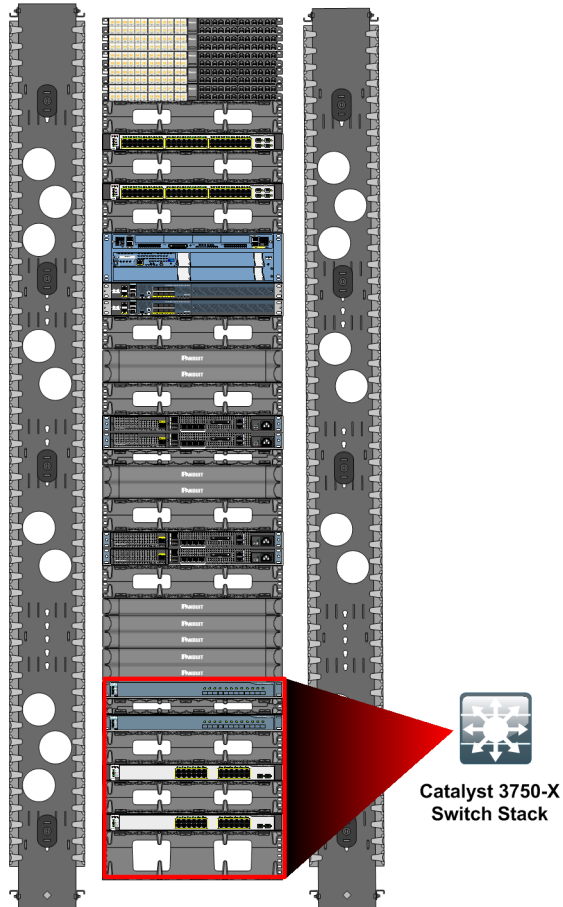

Cable Routing and Management

By employing cable routing and management best practices, the design of the cabinet and rack provides easy access to device components during maintenance windows and ensures proper cooling efficiency. It is imperative that cabling does not block easy insertion and removal of field replaceable units (FRU) on any equipment, or block hot-air exhaust outlets. The patch cords themselves should also be easy to trace in troubleshooting scenarios and easy to move, add, or change during proactive maintenance routines. Table 1 summarizes additional configuration best practices related to effective cable routing and management in the cabinet and rack.

Table 1 - Cable routing and management best practices

| Configuration best practices | ✓ Alignment to Cisco SBA designs |
|---|---|
| Cabinets and racks | |
| Select cabinets and racks large enough to provide optimal cable routing within vertical pathways. | ✓ 28 in. (700 mm), 45 RU Net-Serv® Cabinet provides four wide, vertical pathways. 8 in. (203 mm) wide PatchRunner™ Vertical Cable Management System provides this functionality for the 4-post rack. |
| Cabinets must include appropriate accessories to ensure proper bend radius control and cable routing flexibility. | ✓ Net-Serv® Cabinet in high density configuration provides L-rings and vertical cable management finger sections that align with rack spaces. PatchRunner™ System also includes management fingers and slack management spools. |
| Vertical footprint of cabinets and racks must be sufficient to accommodate all equipment and future needs. | ✓ 52 RU, 4-post open rack, and 45 RU cabinet provide a significant amount of vertical space for current and future needs. Flexibility is a top requirement, in case new equipment or existing device upgrades with larger form factors are inserted into the design. |
| Use blanking panels in racks and cabinets to direct airflow and reserve rack space for future use. | ✓ One RU and 2 RU Panduit tool-less blanking panels are leveraged throughout the design to achieve this design goal. One example of reserving rack space is around the 1 RU Cisco ASA 5510 appliances. Space is reserved to be able to upgrade to Cisco ASA 5585s in the future, which each require 2 RU. |

| Configuration best practices | ✓ Alignment to Cisco SBA designs |
|---|---|
| Patch field management | |
| Select high density patch panels to conserve on valuable rack space. | ✓ Panduit® QuickNet™ 48-port Angled Patch Panels in a 1 RU form factor are used to save rack space. |
| Select patch panels that provide proper bend radius control and cable routing flexibility. | ✓ QuickNet™ Angled Patch Panels facilitate proper bend radius control and minimize the need for horizontal cable managers, which saves additional rack units. |
| Patch panels should be simple to work with allowing for faster moves, adds, and changes. | ✓ Patch panels use pre-terminated QuickNet™ SFQ Series MTP Fiber Optic Cassettes and QuickNet™ Copper Cable Assemblies, which snap in and out with one hand for faster deployment of distribution cabling between cabinet and rack. |
| Horizontal cable management | |
| Horizontal pathways should exist in cabinets and racks to efficiently route cabling while maintaining proper bend radius control. | ✓ Panduit® NetManager™ High Capacity Horizontal Cable Managers provide large front finger openings for high density and curved surfaces for bend radius control. |
| Cable managers must accommodate future growth. | ✓ The appropriate sized NetManager™ Cable Managers are selected in this design to achieve a fill rate of less than 40% to ensure space for future growth. |
| Prefer 1 RU and 2 RU cable managers to encourage re-use. | ✓ One RU and 2 RU horizontal cable managers are primarily used in this design so they can be repositioned after device upgrades or other moves, adds, and changes. |
| Pass-through holes must exist to allow front-to-rear cabling. | ✓ Both the horizontal and vertical cable managers recommended in this design have pass-through holes. |

Inside the Net-Serv® Cabinet, C1, depicted in Figure 5, each of the two Cisco Catalyst 3750-X switches for the server farm provides a maximum of 48-Gigabit Ethernet ports for server downlinks, and 4-Gigabit Ethernet ports for uplinks to the resilient core in the rack, R1. Panduit® TX6A-SD™ 10Gig™ UTP Patch Cords with MaTriX Technology are used from the 48 server farm switch ports to each active server network interface and out-of-band (OOB) management port. Depending on the EtherChannel configuration selected, up to eight Panduit® Opti-Core® 10Gig™ OM3 or OM4 Multimode Duplex LC-to-LC fiber-optic patch cords connect switch uplink ports to a 1 RU QuickNet™ Patch Panel at the top of the cabinet. Two of the four slots available in the patch panel are populated with 6-port (12-strand) SFQ Series MTP Fiber Assemblies. The third slot is filled with a Category 6A Pre-terminated Assembly used for switch management ports, and a filler panel is inserted in the fourth slot, which is reserved for future use.

Figure 5 - Cable routing within C1

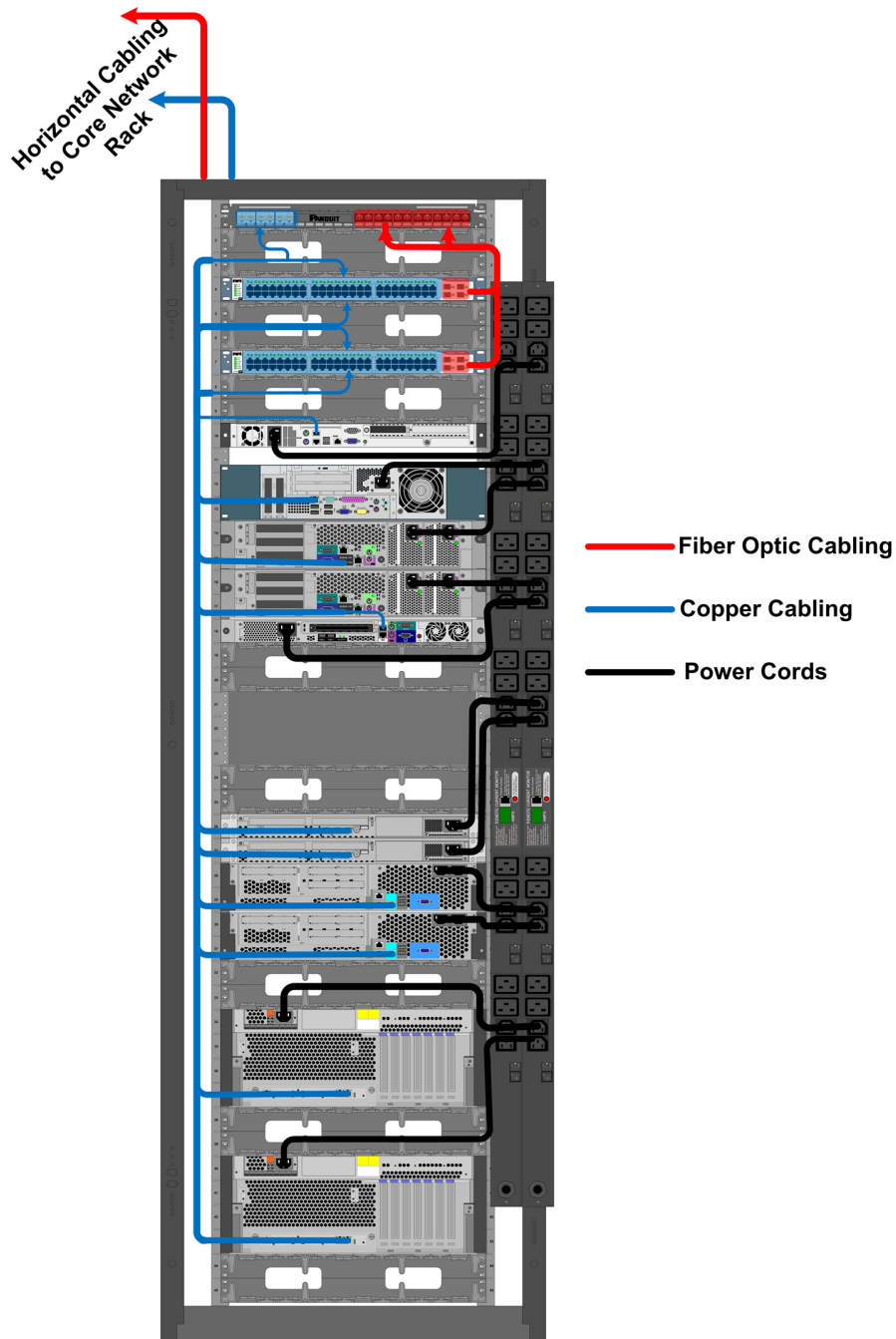
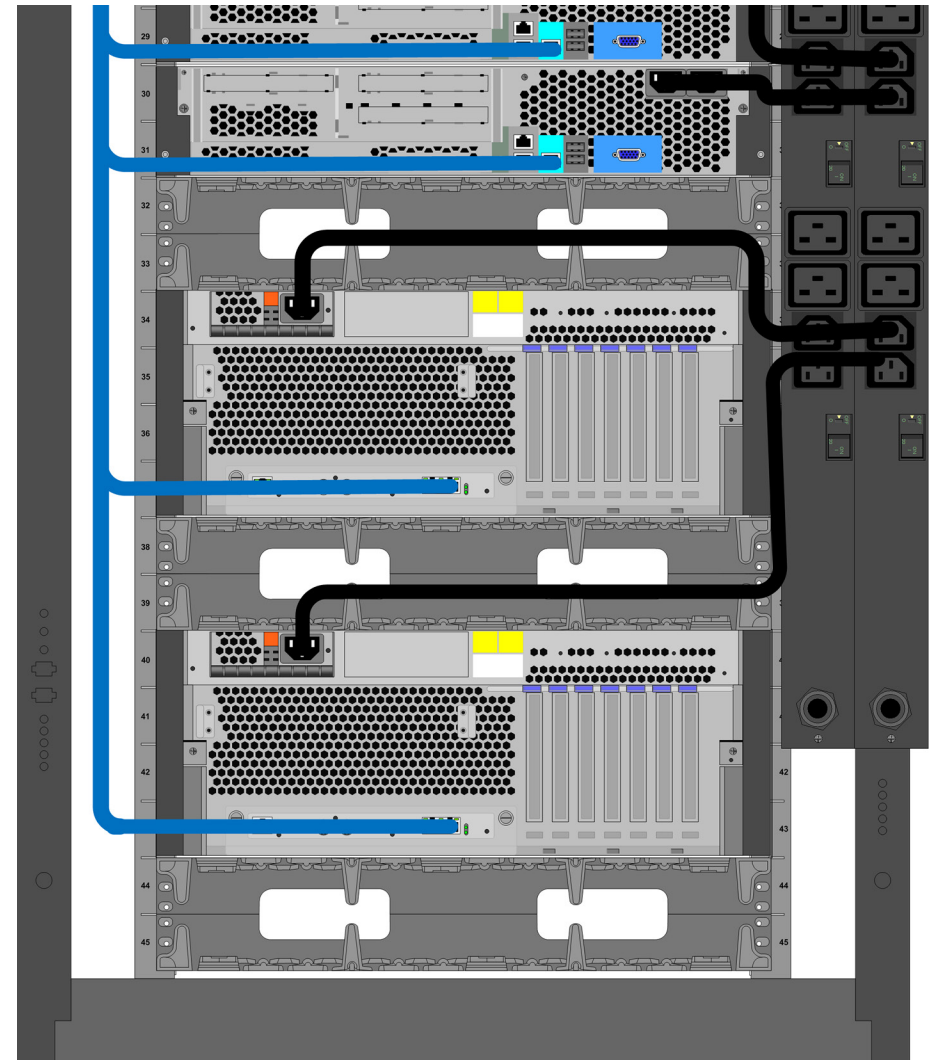

Figure 6 provides a close-up view of the server farm at the bottom of the cabinet to emphasize two important cable routing points. First, notice how the horizontal cable managers are used to route power cords around the secondary power supply bays of the 4 RU servers. If redundant, hot-swappable power supplies are needed in the future, they can easily be inserted without any obstructions. In addition, adequate distance is kept between power cords and copper cabling to avoid possible performance degradation.

Figure 6 - Close-up view of server farm cable routing



Inside the 4-post rack, R1, depicted in Figure 7, each of the two Cisco Catalyst 3750-X switches for the client access portion of the campus module provides a maximum of 48-Gigabit Ethernet ports for end-user devices on the office floor. Four-Gigabit Ethernet ports on these switches provide uplinks to the Cisco Catalyst resilient core located at the bottom of the rack. Panduit® TX6A-SD™ 10Gig™ UTP Patch Cords with MaTriX Technology are routed from each 48-port client access switch to the QuickNet™ Angled Patch Panels at the top of the rack. These same Cat 6A patch cords are also used to connect appliances from the firewall, application optimization, and WAN guides to the resilient core. If the Catalyst 4507R+E or Catalyst 6504-E VSS pair is selected for the resilient core, a mix of copper and fiber-optic line cards are inserted into the chassis along with supervisor modules. If the Catalyst 3750-X stack is used, there needs to be separate Catalyst 3750-X switches designated for fiber optic and copper connectivity.

Five QuickNet™ Angled Patch Panels exist at the top of this rack. The left side of this combined patch field is populated with 6-port QuickNet™ Cat 6A Pre-Terminated Assemblies that run to other telecommunications closets and the patch field in C1. The right side of the patch field is filled with SFQ Series MTP Fiber Assemblies. These assemblies replicate patch panel ports in C1 and are also used to replicate ports in other cabinets that will be added in a future transition to the data center architecture. Splitting the copper and fiber-optic patch fields facilitates easier cable routing and management within the rack, and ensures adequate space between these cables, as recommended by TIA-942.

Figure 7 - Cable routing within R1

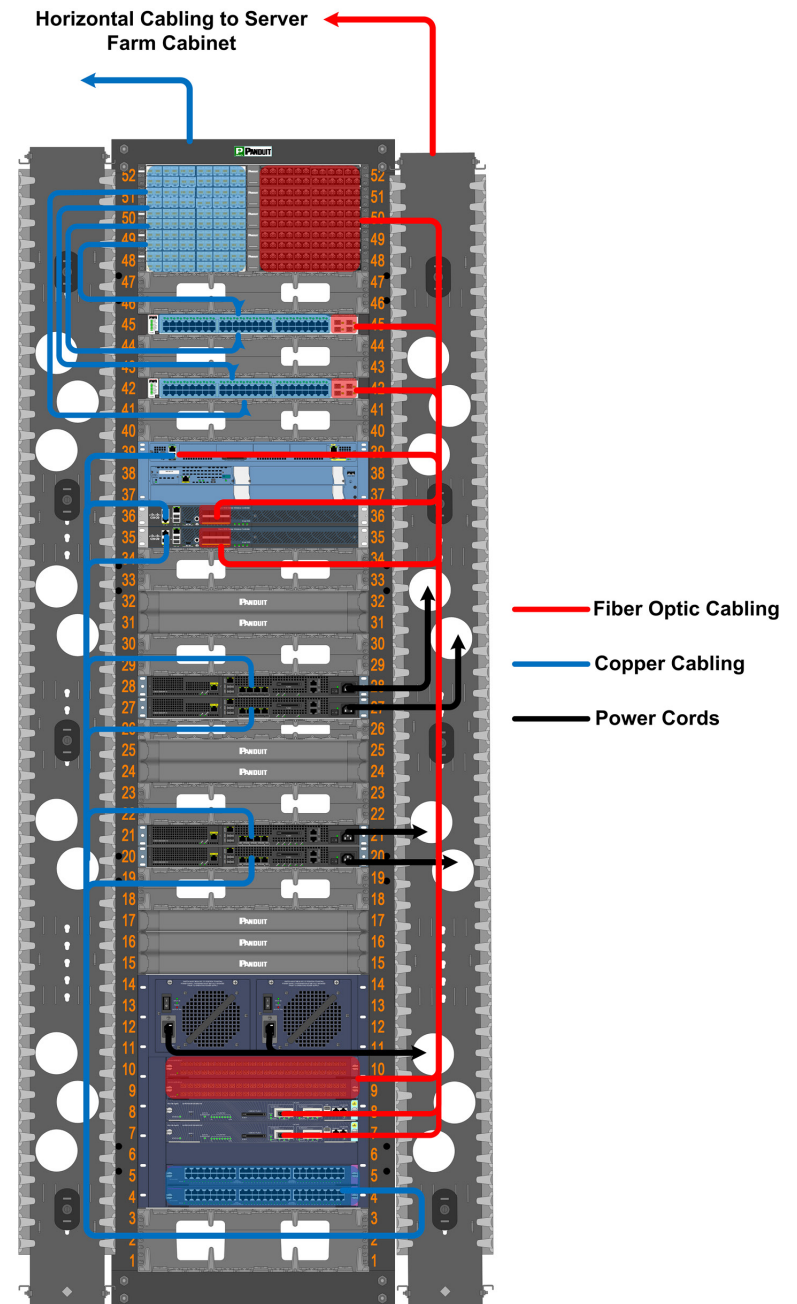
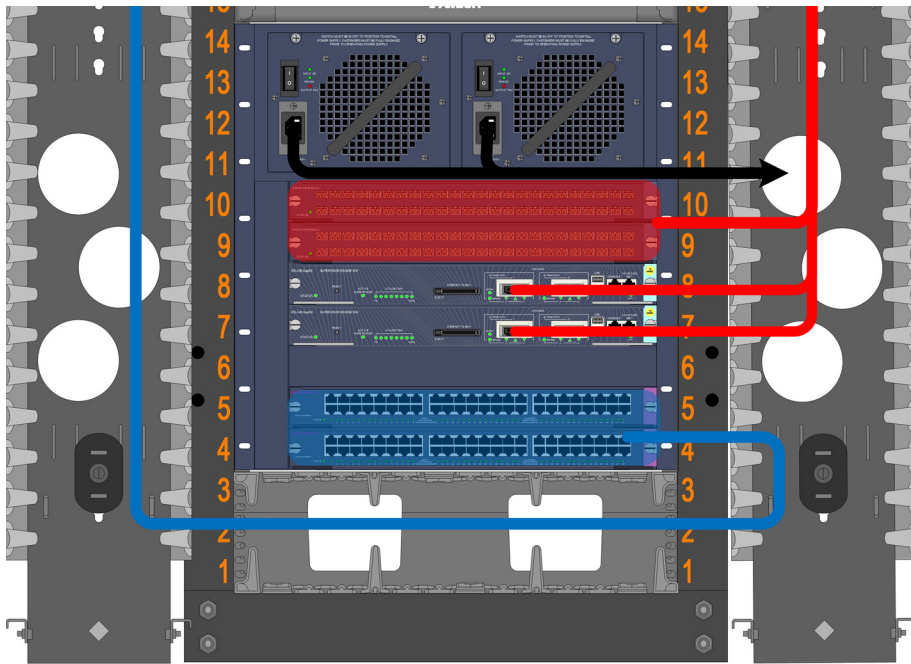

Figure 8 zooms in on the Cisco Catalyst 4507 in R1 to highlight several important cable routing points. First, notice that the 3 RU horizontal cable manager at the bottom of the rack is used to direct copper cabling up the PatchRunner™ Vertical Cable Manager located on the front-left side to ensure proper separation of the copper cabling from the fiber-optic cabling and power cords. Also, all cabling is routed to the right of the chassis-based switch to avoid obstructing access to the field replaceable fan module on the left of the switch. Finally, power cords are run through the pass-through holes in the PatchRunner™ System to POUs mounted in the back of the rack.

Figure 8 - Close-up view of resilient core routing



Pathways

Structures must also exist to provide a robust and modular pathway through which bulk cabling can be effectively routed between the Cisco SBA foundation cabinet and rack. In addition, bulk cabling from access devices and other telecommunications rooms throughout the building must be routed through an opening in the foundation CER or CTR to R1. Since there is a slab floor used in this design, the only option is to route cabling within overhead pathways. Figure 9 provides a close-up view of how the grounding, copper, and fiber-optic cabling routes to R1 via the overhead pathways.

Figure 9 - Close-up view of pathways and cabling over R1

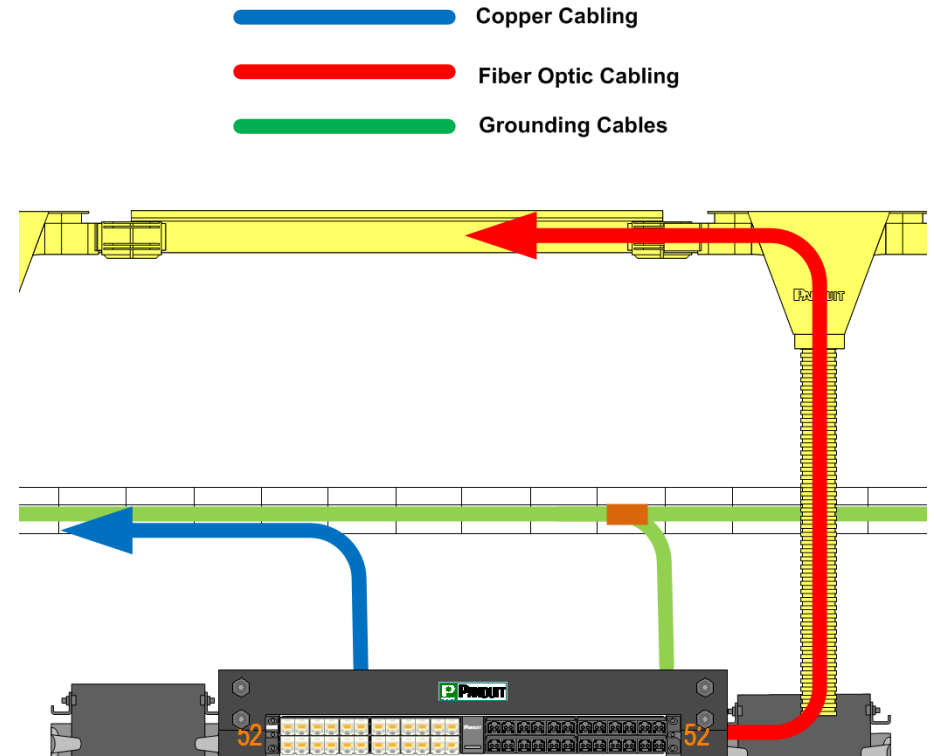

Cabling from the rest of the building should be fed into the room close to either end of the overhead pathways, as depicted by the red circles in Figure 10. This configuration allows for an easier transition for thick cable bundles into the pathways and over to R1.

Figure 10 - Example locations where bulk cabling enters the CER or CTR

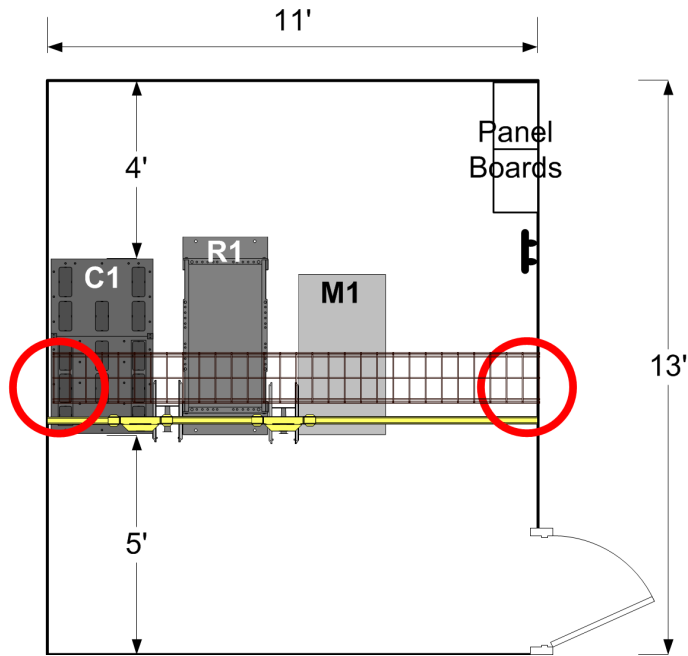

Two different types of overhead pathways are used to keep copper and fiber-optic cabling separated, as recommended in the TIA 942 Standard. Other key configuration best practices related to pathways are listed in Table 2.

Table 2 - Pathways configuration best practices

| Configuration best practices | ✓ Alignment to Cisco SBA designs |
|---|--|
| Maintain adequate distances between cabinet, rack, overhead pathways, and the ceiling, per the standards. | ✓ Panduit® Wyr-Grid™ System mounts 4 in. (102 mm) above top of cabinets, and FiberRunner® System Channels mount 12 in. (305 mm) above the bottom of the Wyr-Grid™ System. An 18 in. (457 mm) buffer is kept between the ceiling and top of the FiberRunner® System. |
| Use different pathways to keep adequate separation between copper and fiber-optic cabling. | ✓ Wyr-Grid™ System routes the Cat6 copper cabling connecting the QuickNet™ Assemblies between patch panels in the cabinet and rack. The FiberRunner® System routes the flat-ribbon cable assemblies between the SFQ Series MTP Fiber Assemblies in the patch panels. In addition, knockouts on the roof of the cabinet allow for proper cable entry. |
| Provide adequate room in pathways for future expansion. | ✓ Pathways have been sized to ensure a best-practice channel fill rate of less than 50%. A 2 in. (51 mm) x 2 in. (51 mm) channel size is used for the FiberRunner® System. The Wyr-Grid™ System is 12 in. (305 mm) wide with 4 in. (102 mm) high sidewalls. |
| Configuration should allow for simple moves, adds, and changes. | ✓ QuikLock™ Assembly features on the FiberRunner® Systems eliminate or minimize the need for tools to assemble the system. Also, multiple spillout options provide versatility to make transitions to cabinets. |
| Ensure proper protection for cabling into pathways. | ✓ FiberRunner® System fittings provide minimum 2 in. (50.8 mm) bend radius to protect against signal loss due to excessive cable bends. |
| Spillout options should provide bend radius protection for both copper and fiber-optic cables. | ✓ FiberRunner® System and Wyr-Grid™ System both provide spillout accessories that ensure bend radius control for cable protection. |
| Properly seal openings made to transition cabling to pathways. | ✓ Cool Boot® Cabinet Top Air Sealing Fitting is used on the Net-Serv® Cabinet to keep the open cutouts sealed. |

Two other types of cables that must be routed outside the cabinet and rack are power distribution and grounding cables. Besides maintaining separation between copper and fiber optic cables, the TIA-942 Standard also recommends keeping an adequate distance between power and telecommunications cables. This separation is especially necessary to minimize longitudinal coupling between power cabling and twisted-pair copper cables. Since the foundation cabinet and rack are situated on a slab floor, these cables must also run in the overhead space. A more detailed discussion of power distribution, grounding and bonding configuration, and their associated cabling appears in the next section, Environmental Design.

Environmental Design

To achieve maximum efficiency and optimization in this design, the appropriate cooling design, power distribution, and grounding and bonding configurations must be employed. Best practices followed in larger data center implementations are also applicable here. In the cooling design, the objective is to provide adequate cold air supply to the IT equipment and properly remove hot exhaust air. With a properly implemented power distribution system, IT equipment remains available even during power outages or service disruptions. Finally, the grounding and bonding systems must be able to maximize equipment uptime, maintain system performance, and protect personnel.

Cooling System

A sustainable cooling system design that follows industry best practices is essential to the success of the Cisco SBA deployments. Not only is IT equipment safe from unplanned downtime due to overheating, but significant OpEx savings are realized through more efficient energy usage.

Airflow direction is a particular challenge in the R1 core rack. Network service appliances found in the Cisco SBA deployment guides for firewall, application optimization, and WAN have varied airflow characteristics that make proper cooling efficiency a challenge. Therefore, a 4-post open rack system is selected for hosting these devices. In addition, special attention is given to the proper vertical arrangement of this equipment to achieve inlet temperatures of 80.6° F (27° C) or less, which is deemed acceptable by the ASHRAE industry standard.

The total IT equipment heat-load and airflow for the room is estimated to be 8 kilowatts (kW) and 1020 CFM, respectively. This is based on a typical device utilization of 50% of nameplate power. Based on manufacturer's specifications, one Liebert® CRV™ Row-Based Cooling unit (20 kW; 2453 CFM) placed next to the 4-post rack provides sufficient cooling airflow and cooling capacity for the heat load of the room. All electrical and coolant

pipings connections can be made from the top and/or bottom of the unit to accommodate the building's plumbing configuration. Figure 11 and Figure 12 show the results of a Computational Fluid Dynamics (CFD) analysis on the foundation CER or CTR. CFD analysis models are an integral part of designing and validating any size technology deployment.

Figure 11 - Cross-sectional view of R1 temperature distribution through the centerline of the rack

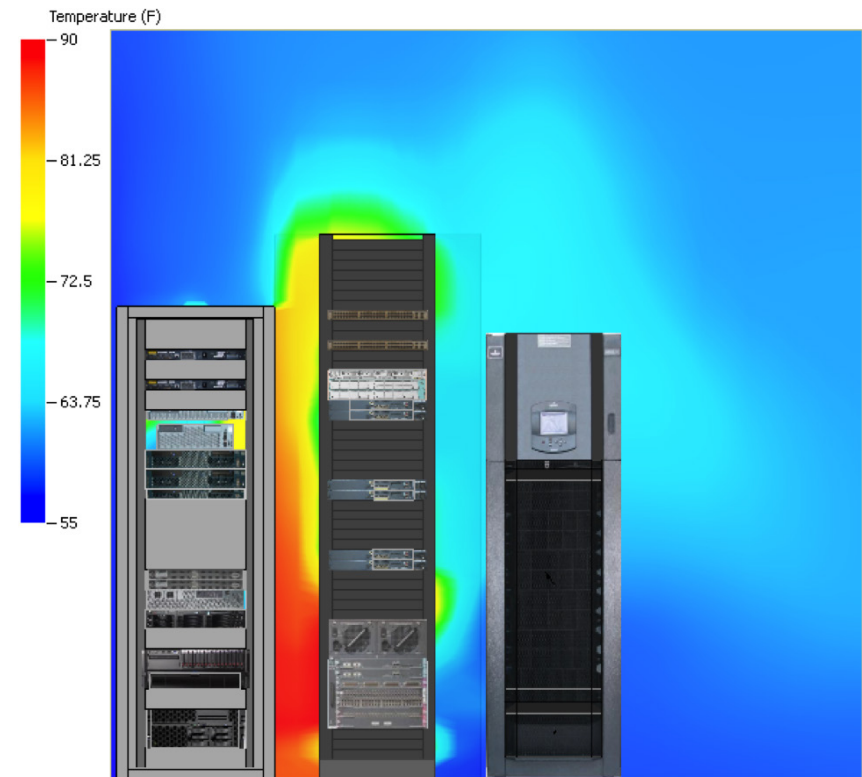
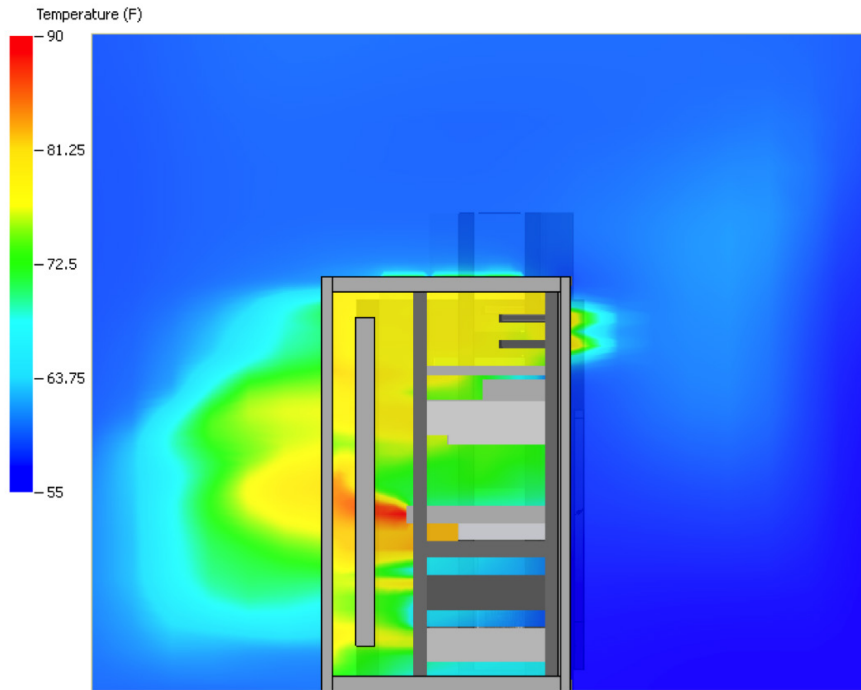

Figure 12 - Cross-sectional view of C1 temperature distribution through the centerline of the cabinet



The CFD analysis reveals the following pertinent details:

- The maximum inlet temperature for the IT equipment is 81°F (27.2° C). Liebert® CRV™ supply temperature set point of 55° F is necessary to maintain this acceptable inlet temperature.
- The open rack allows an adequate amount of cool air to reach all the varied inlet locations (front, rear, and side) of the network gear.
- The Cisco Catalyst 4507 or Catalyst 6504 switch exhaust is prevented from entering the server inlets because the hot air is buffered by the PatchRunner System and the side panel on C1.
- Devices like the Cisco 3945 Integrated Service Router with left-side inlets should not be located directly above the Cisco Catalyst 4507 switch because the switch exhausts air out the left side of the chassis.
- The servers in C1 are sufficiently cooled, but the Cisco Catalyst 3750-X switches in the top of the cabinet are at 80° F (26.7° C) because their inlets are in the rear of the cabinet and take in exhaust air from the servers.

Power Distribution

The use of an uninterruptable power supply (UPS) is recommended for this design to provide high availability in the event of a power outage from the utility. This UPS should be placed outside of the room to avoid additional space and power consumption. Two redundant panel boards inside the room are fed from the UPS and provide the maximum required 16 kW of power at 208 Volts to all active equipment.

Power is delivered via conduit from the panel boards to junction boxes mounted over the rack, cabinet, and cooling unit. In this design, the cooling unit is also protected by the UPS because a room of this size is especially vulnerable to rapid overheating in the absence of cold air delivery.

Inside the cabinet and rack, each of two Panduit 60 Amp, 208 Volt, Three-Phase POU's feed one of two redundant power supplies in all IT equipment. During typical operation, each POU carries no more than 50% of the nameplate rated load. However, each is sized to carry 100% of the load in case one of the power paths fails. Input cords from these POU's route to the overhead junction boxes.

Grounding and Bonding

The grounding system is an active functioning network designed to maximize equipment uptime, maintain system performance, and protect personnel. Proper grounding and bonding is essential for efficient data center performance. The purpose of the grounding system is to create a robust path for electrical surges and transient voltages to return either to their source power system or to earth. Lightning, fault currents, circuit switching, activation of surge protection devices (SPD), and electrostatic discharge (ESD) are common causes of these electrical surges and transient voltages. An effective grounding system can minimize or eliminate the detrimental effects of these events.

The Panduit® StructuredGround™ Grounding System complies with Building Industry Consulting Service International (BICSI) TDM Manual, 10TH Edition and J-STD-607-A, TIA-942, IEEE Standard 1100 (IEEE Emerald Book), UL, and CSA. These standards require that well-designed grounding systems are:

- Intentional.
- Visually verifiable.
- Adequately sized to handle expected currents safely.
- Designed to direct potentially damaging currents away from sensitive communications equipment.

All metallic components must be bonded to a grounding network to prevent electrical shock. In the Cisco SBA foundation, this includes the Wyr-Grid™ System, cabinet, rack, mechanical devices, and IT equipment contained within the cabinet and rack. Figure 13, Figure 14, and the bullet points that follow detail the elements of the Panduit® StructuredGround™ Grounding System and how a sample rack and its associated IT equipment are properly grounded using these elements.

Figure 13 - Components of a Panduit® StructuredGround™ Grounding System

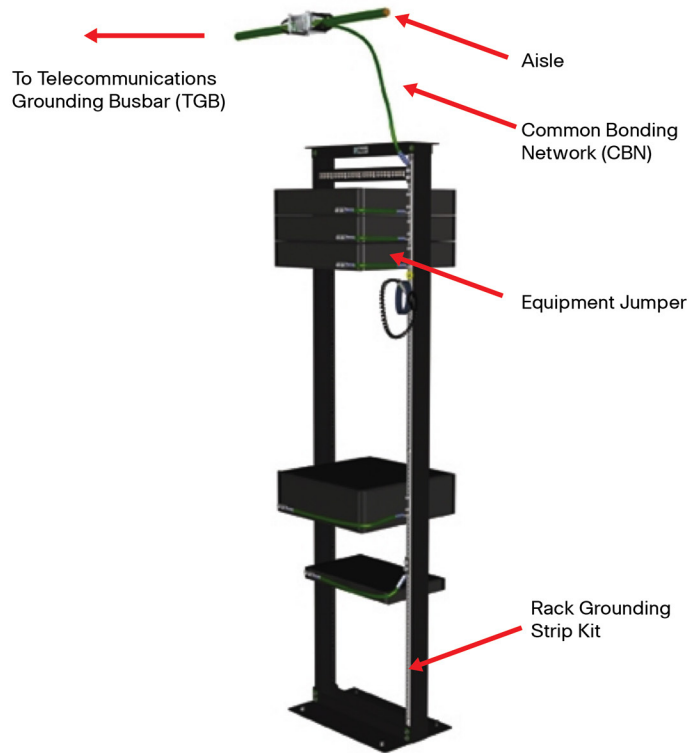
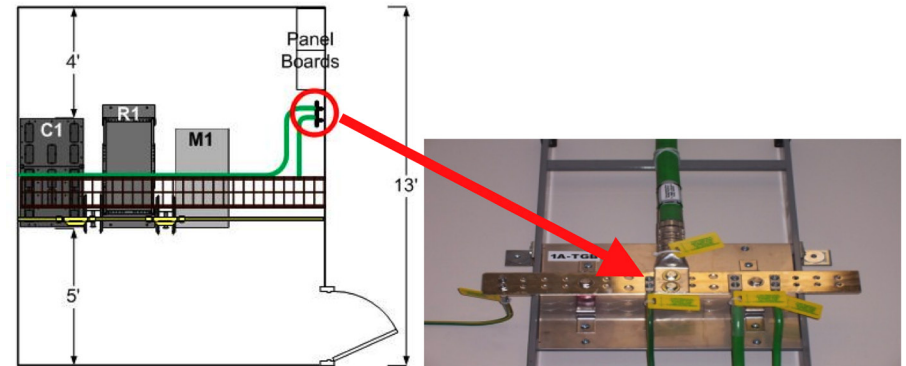

Figure 14 illustrates the Telecommunications Grounding Busbar (TGB) in the CER or CTR mapped to a photograph of a real TGB. This TGB is connected back to a Telecommunications Bonding Backbone, which ultimately leads back to the Main Electrical Services Ground.

Figure 14 - Telecommunications Grounding Busbar (TGB)



Below are details about how a sample rack and its associated IT equipment are properly grounded using these elements.

- An Aisle Ground, typically #2 AWG insulated copper code conductor, bonds to the TGB and runs along the side of the Wyr-Grid™ System, as depicted in Figure 14.
- A rack grounding strip (RGS) kit is affixed to both the cabinet and rack, which provides the lowest impedance path to ground.
- Equipment Jumper Kit bonds network equipment to the grounding strip of the rack or cabinet. Cisco requires that all Cisco equipment be properly grounded or the warranty could be voided. Instructions provided for each device details how to attach the Jumper Kit to the equipment. Figure 15 illustrates the components involved in properly grounding a Cisco Unified Computing System (UCS) Fabric Interconnect.

Figure 15 - Elements used to ground a Cisco UCS Fabric Interconnect

1. Equipment Jumper Kit cable
2. Screws, M4, with square cones washers
3. NRTL listed grounding lug
4. Close-up view of the grounding pad on the chassis

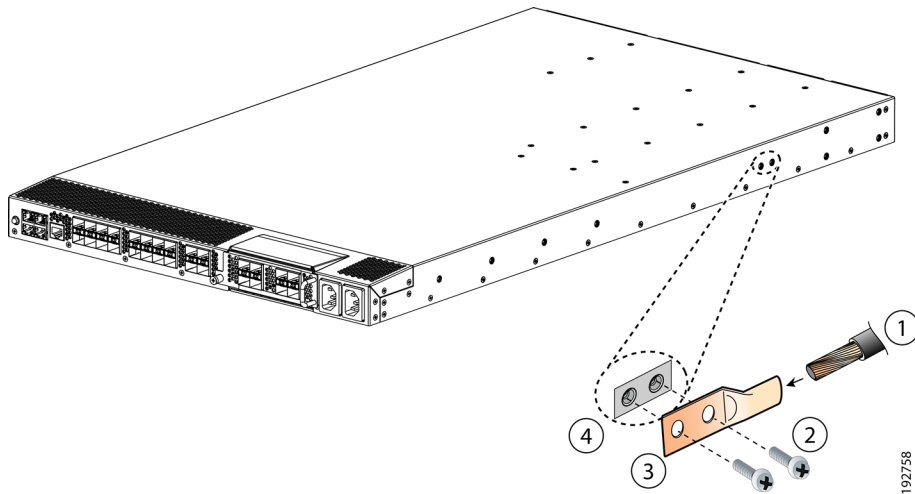

- The Common Bonding Network (CBN) Jumper Kit connects the RGS and rack to the Aisle Ground conductor via a copper compression HTAP. The Aisle Ground conductor runs alongside of the Wyr-Grid™ System and is supported by auxiliary cable brackets every 18 in. (457 mm) to 24 in. (610 mm).
- The Wyr-Grid™ System must be bonded to the TGB via a minimum 6 AWG jumper in at least one location, as depicted in Figure 14.
- The Liebert® CRV™ Row-Based Cooling unit is also properly bonded to the TGB via a CBN Jumper Kit.

Design State Two—Cisco SBA Data Center

As organizations continue to grow and require greater technological capabilities, a larger footprint is needed to house the accumulation of IT equipment and their supporting power and cooling facilities. A more robust architecture, like that presented in this guide, becomes necessary. The logical architecture and physical configuration of the network core presented in the last section is designed with maximum modularity for an easy transition to this data center when necessary.

Top-Down Room View

The room selected for this design is only a slight variation on the network core CER or CTR. The width of the room is kept the same at 13 ft. (3.96 m), but the length is extended to 18 ft. (5.49 m) to accommodate two new cabinets for a total of 234 ft² (21.74 m²). As depicted in Figure 16, C1 and R1, along with their supporting Liebert® CRV™ Row-Based Cooling unit (20 kW), M1, have been moved into this larger footprint. Two Panduit® Net-Serv® Cabinets, labeled C2 and C3, and an additional cooling unit, labeled M2, have also been inserted into the design. In addition, the overhead pathways are reprovisioned and extended for proper routing of telecommunications and grounding cables. Adequate free space is included for unobstructed access to equipment for routine maintenance activities and for proper airflow.

Figure 16 - Top-down view of Cisco SBA data center mapped to the logical architecture

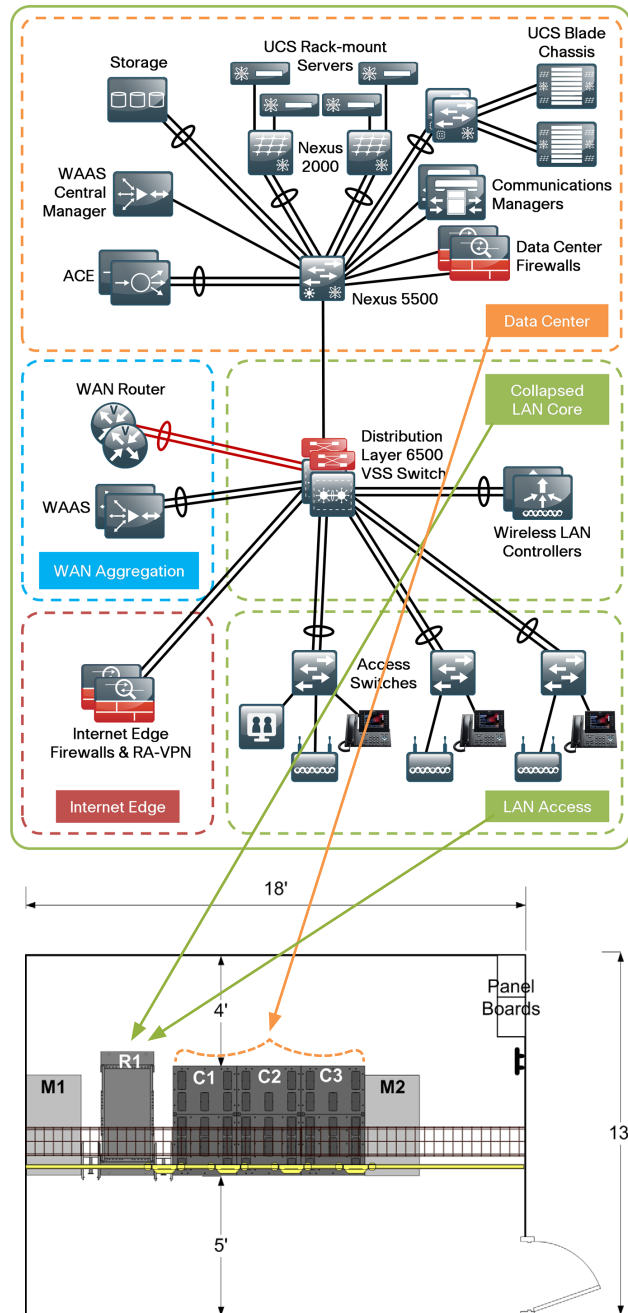

The Net-Serv® Cabinet, labeled C3, contains the storage elements of the Fibre Channel data center design module. This includes a storage array composed of a dual-headed controller, disk shelves, and SAN switches located at the top of the cabinet. An additional Net-Serv® Cabinet, labeled C2, consists of the switches outlined in the Ethernet data center design and Cisco UCS nodes for compute resources. The only change to either C1 or R1 is the addition of Cisco Application Control Engine (ACE) appliances into R1, which are detailed in the application resiliency module. Cabling, cable managers, patch panels, grounding kits, and POUs are interspersed with the IT equipment to provide the physical infrastructure capabilities detailed throughout this guide.

Rack Elevations

Because C1 and R1 from the Cisco SBA network core are easily transitioned to this configuration, they are not readdressed here. Figure 17 shows a rack elevation of the front of all equipment in the new data center footprint. Just like the original room layout, this data center has a concrete slab floor that supports all four structures. In addition, no suspended ceiling is installed in this new footprint. The total room height should also remain at a minimum of 11 ft. (3.4 m) off the slab floor to allow the proper amount of buffer space between the cabinets, rack, overhead pathways, and the building spaces.

Figure 17 - Front view of rack elevation of the Cisco SBA data center

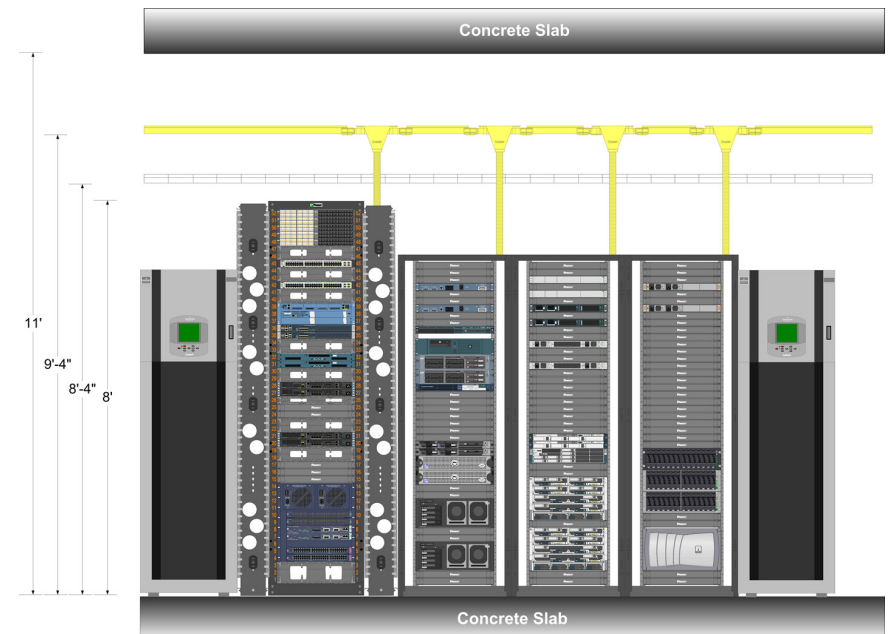

The priorities used to arrange the IT equipment, as outlined in the *Cisco SBA—Data Center Deployment Guide*, do not change from the network core. The new elements of the logical architecture—storage and compute optimized for virtualization—are organized together and kept in separate cabinets from the core networking and rack-mount server farm cabinets transitioned over from the network core.

Figure 18 illustrates the rack elevation from the rear view. In this depiction, the elements are labeled and mapped from the logical architecture. The same two tiers of overhead cable routing pathways are kept from the network core design. The Wyr-Grid™ System and FiberRunner® System have been engineered with scalability and modularity in mind so that it is easy to extend their reach to the newly added cabinets required by the data center design.

Figure 18 - Rear view of rack elevation of the Cisco SBA data center

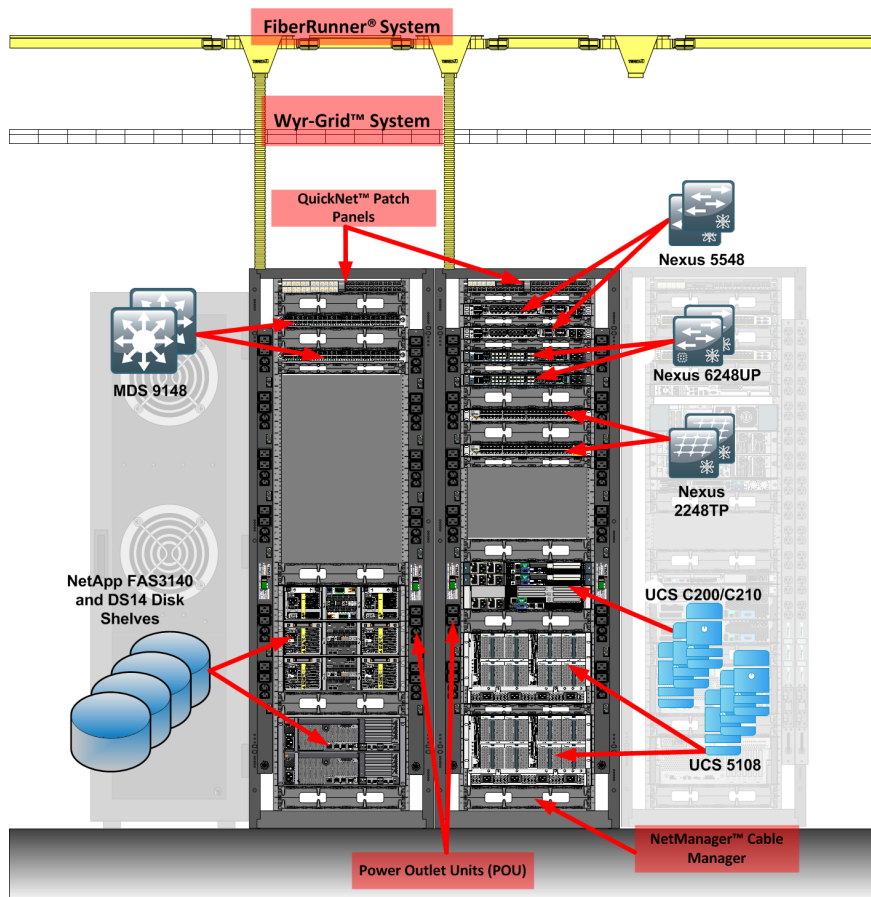

Cable Routing and Management

The benefits and key configuration best practices for cable routing and management do not differ in the data center design versus the network core design. By employing cable routing and management best practices, this design provides easy access to device components during maintenance windows and ensures proper cooling efficiency. Refer to Table 1 to review the best practices.

The Net-Serv® Cabinet, C3, shown in Figure 19, is comprised almost completely of fiber-optic cabling. Panduit® Opti-Core® 10Gig™ OM3 or OM4 Multimode Duplex LC to LC fiber-optic patch cords connect the NetApp FAS3140 controllers to the Cisco Multilayer Data Center Switch (MDS) 9148 switches near the top of the cabinet for Fibre Channel SAN connectivity. A maximum of 40 front-end connections from a two controller, active-active configuration can be used. These same patch cords also connect the NetApp controllers to the disk shelves. SFQ Series MTP Fiber Assemblies are installed in the 1 RU QuickNet™ Angled Patch Panel at the top of the cabinet. Several assemblies route to C2 for the Fibre Channel traffic sent from the Cisco Nexus 5500 switch and the Cisco UCS 6248 Fabric Interconnect. A mixture of Cat 6A Pre-Terminated Assemblies and SFQ Series MTP Fiber Assemblies are also inserted into this patch panel for switch management and Ethernet packets from the NetApp controllers for the Internet Small Computer System Interface (iSCSI) storage protocol to R1.

Figure 19 - Cable routing within C3

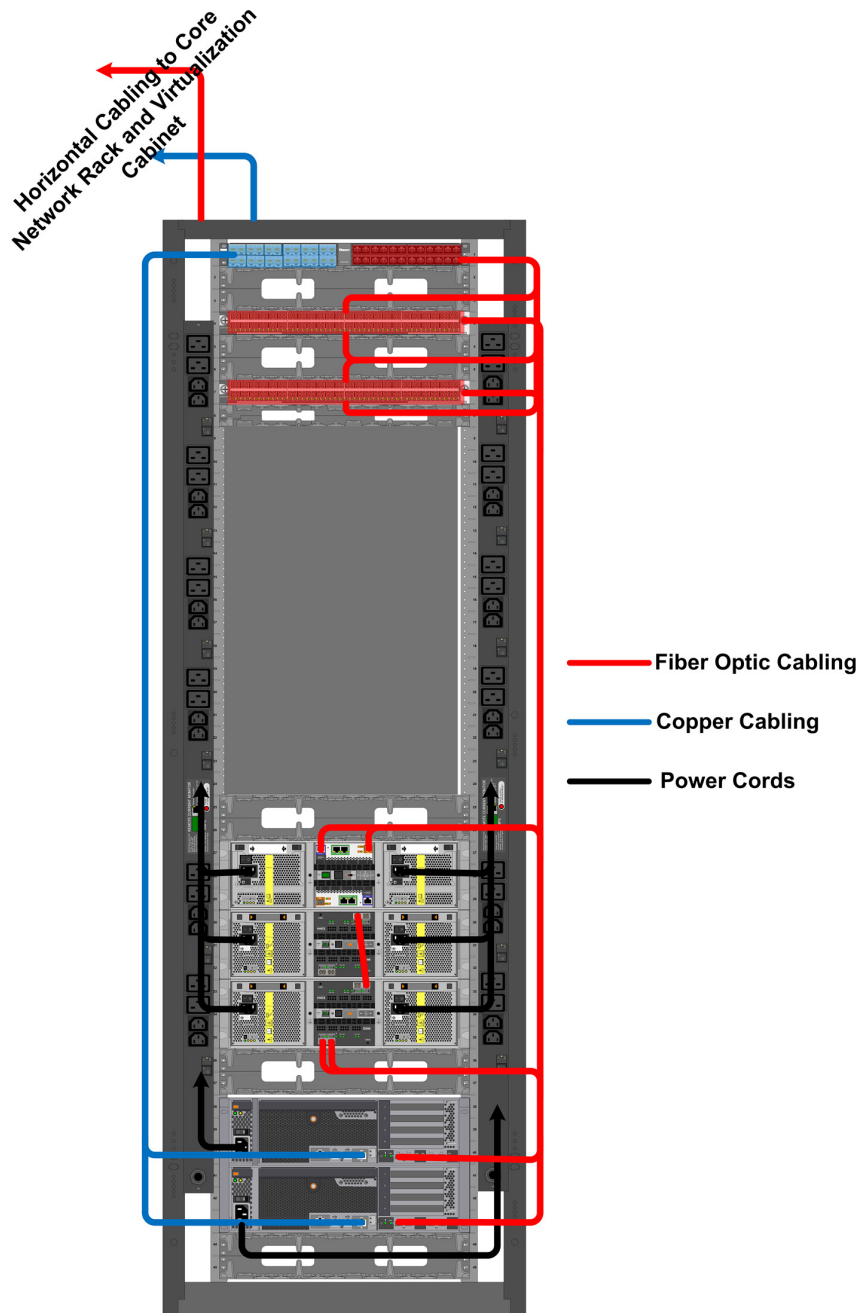
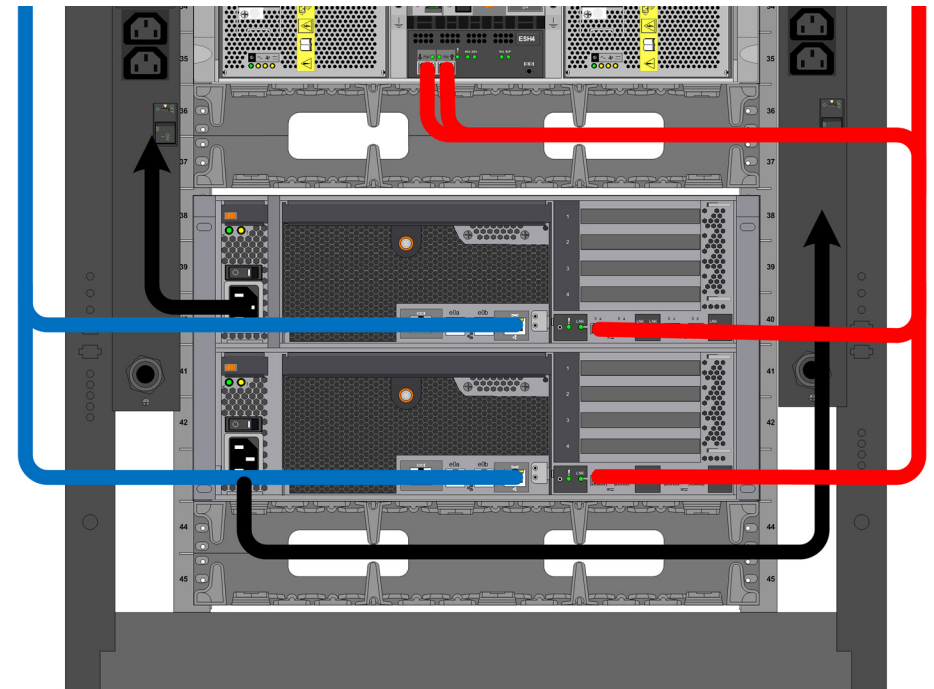

Figure 20 provides a close-up view of the storage cabinet to highlight the cable routing. Unlike C1 and R1, the POUs in C3 are split between the left and right sides of the cabinet to accommodate the varying positions of IT equipment power supplies.

Figure 20 - Close-up view of the SAN controller cable routing



Inside C2, shown in Figure 21, a variety of cabling media is used to connect the various types of servers to the networking infrastructure. Panduit® 10Gig™ SFP+ Direct Attach Copper Cable Assemblies connect the Cisco UCS chassis with the UCS 6248 Fabric Interconnects near the top of the rack. Rack-mount servers primarily use Panduit® TX6A-SD™ 10Gig™ UTP Patch Cords with MaTriX Technology to connect to the Cisco Nexus 2248TP Fabric Extenders near the top of the rack via 1000BASE-T. In the case that these servers need SAN connectivity, converged network adapter (CNA) interface cards would be inserted into the servers and connected to the Cisco Nexus 5500 switch near the top of the rack using SFP+ cables. Uplinks and all out-of-band switch management run to the 1 RU QuickNet™ Angled Patch Panel at the top of the rack populated with Cat 6A Pre-Terminated Assemblies and SFQ Series MTP Fiber Assemblies.

Figure 21 - Cable routing within C2

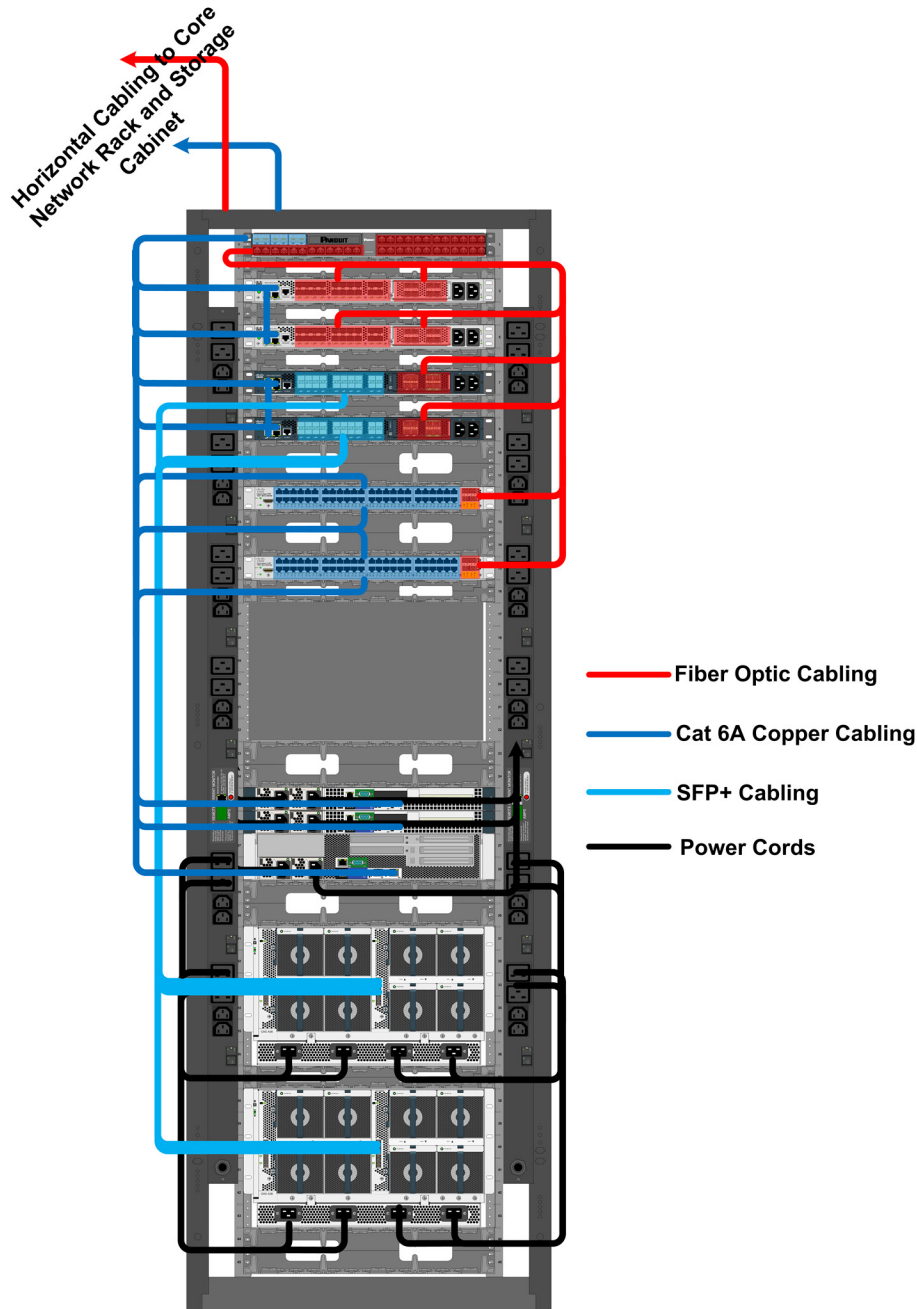
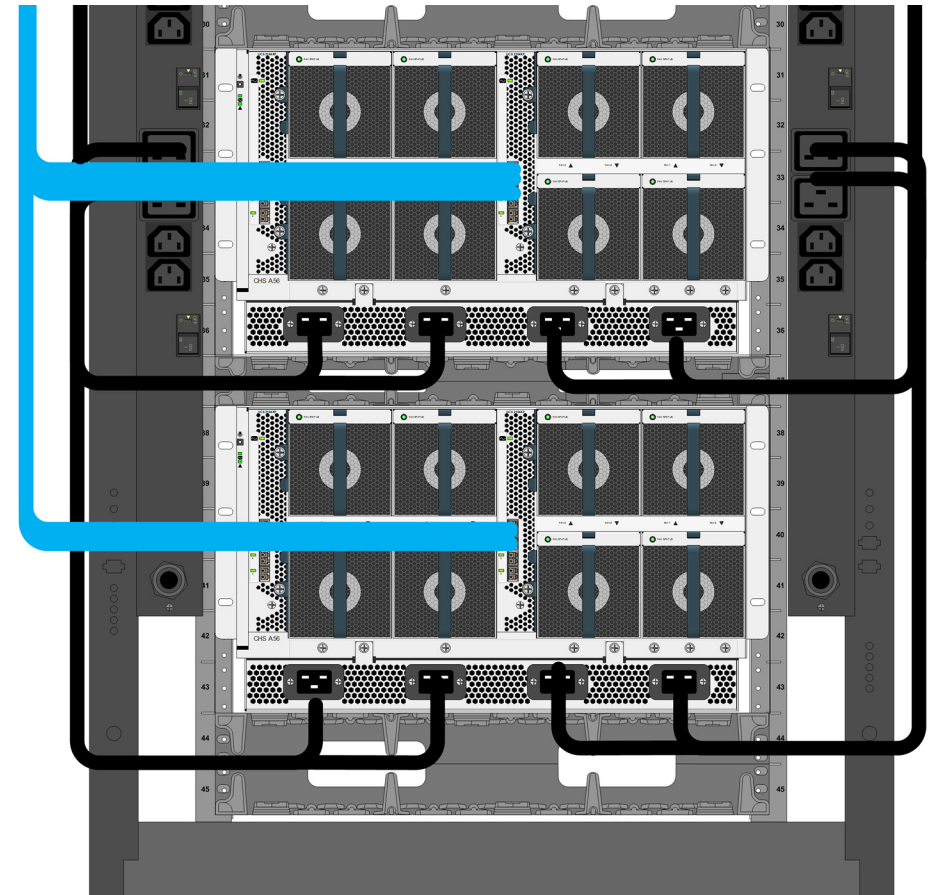

Figure 22 provides a close-up view of the Cisco UCS chassis to highlight the cable routing. As with the other cabinets and rack, horizontal cable managers are used to route cabling around FRUs.

Figure 22 - Close-up view of the Cisco UCS chassis cable routing



Environmental Design

As with the network core design, maximum efficiency and optimization for the Cisco SBA data center requires the appropriate cooling design, power distribution, and grounding and bonding configurations. Because the physical infrastructure of the network core uses modularity as a key design parameter, the transition to the data center is very straightforward. Existing cooling and power elements are simply moved to the new location.

Cooling System

The total IT equipment heat-load and airflow for the Cisco SBA data center footprint is estimated to be 15 kilowatts (kW) and 2405 CFM, respectively. This is based on a typical device utilization of 50% of nameplate power. Based on manufacturer's specifications, a second Liebert® CRV™ Row-Based Cooling unit (20 kW; 2453 CFM) needs to be added to this design to provide sufficient cooling airflow and cooling capacity for the increased heat load of this data center. This second CRV™ unit also adds N+1 redundancy to the cooling infrastructure of the room. All electrical and coolant piping connections can be made from the top and/or bottom of unit M2 to accommodate the building's plumbing configuration. Figure 23 and Figure 24 show the results of a CFD analysis on the data center.

Figure 23 - Cross-sectional view of R1 temperature distribution through the centerline of the rack



Figure 24 - Cross-sectional view of C2 temperature distribution through the centerline of the cabinet

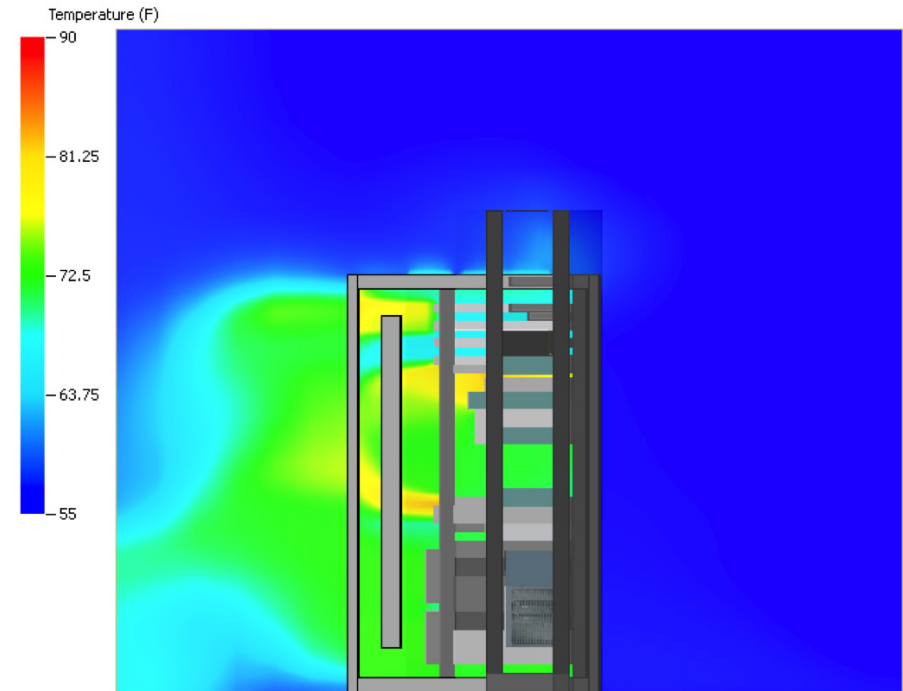

The CFD analysis reveals the following pertinent details:

- The maximum inlet temperature for the IT equipment is 79°F (26.1°C). Liebert® CRV™ supply temperature set point of 55° F is necessary to maintain this acceptable inlet temperature.
- R1 and server farm cabinet, C1, from the network core are transitioned into this room and have almost the same inlet temperatures that were seen in the Cisco SBA network core CFD results.
- The second CRV™ unit provides plenty of airflow even for the virtualization cabinet, C2, which has high airflow requirements. The maximum inlet temperature for this cabinet is 61° F (16.1° C). Additional rack mount servers or an additional Cisco UCS chassis could be added to this cabinet.
- Storage cabinet, C3, has an inlet temperature of 59° F. (15°C). Additional disk shelves can easily be added to this cabinet for greater storage capacity.
- Multiple CFD analysis runs were performed to ensure the most optimal arrangement of the cabinets and rack. The lineup indicated in Figure 23 provided the lowest inlet temperatures to all IT equipment.

Power Distribution

Similar to the network core, the Cisco SBA Data Center design also uses a UPS located outside the room to feed two panel boards. However, the UPS requires additional capacity to service the increased load to a maximum of 30 kW at 208 Volts for all equipment. Once again, power is delivered via conduit from the panel boards to junction boxes mounted over the rack, cabinets, and cooling unit. Then, input cords from POU's mounted inside the cabinets and rack route to these overhead junction boxes. The same Panduit 60 Amp, 208 Volt, Three Phase POU's from the network core design are used in newly added cabinets, C2 and C3, to maintain standardization of components within the cabinets and rack.

Grounding and Bonding

As with the cooling system and power distribution designs, very little change is necessary to the grounding system to migrate to the data center design. After inserting the IT equipment called for by the architecture into the cabinets, C2 and C3, they each must be properly bonded to the RGS using the Equipment Jumper Kits just like the devices in C1 and R1. Then, a Common Bonding Network (CBN) Jumper Kit connects the RGS to the Aisle Ground conductor running alongside of the Wyr-Grid™ System using a copper compression HTAP and clear cover HTWC.

Identification

To easily identify and manage all the elements of the network core and data center designs, an effective labeling strategy must be employed. Proper labeling provides two very important benefits: determining locations of components and defining system connections. It is this combination of determining and defining that allows the quick, clear communication that is required to accurately install, maintain, and repair critical infrastructure components, which results in efficient and consistent data center maintenance.

The following subsections define the various identifiers needed for the physical infrastructure. They are applicable for the entire room.

Space Identifier

A space identifier should have a format of:

s
Where

s = any object consuming floor space is labeled with the letters C for cabinet, R for rack, or M for mechanical device, plus a sequential number

Example:

C1

This is cabinet number 1 when counting sequentially from left to right and standing in front of the equipment.

Equipment Identifiers

An equipment identifier should have a format of:

s-a
Where

s = any object consuming floor space is labeled with the letters C for cabinet, R for rack, or M for mechanical device, plus a sequential number

a = location of equipment in the cabinet based on the RU position of the top-left corner of the equipment mounting flange

Example:

C1-24

This identifies that the equipment is located at RU space 24 in cabinet C1 of the Cisco SBA architecture, as shown in Figure 25.

Figure 25 - Equipment at RU space 24

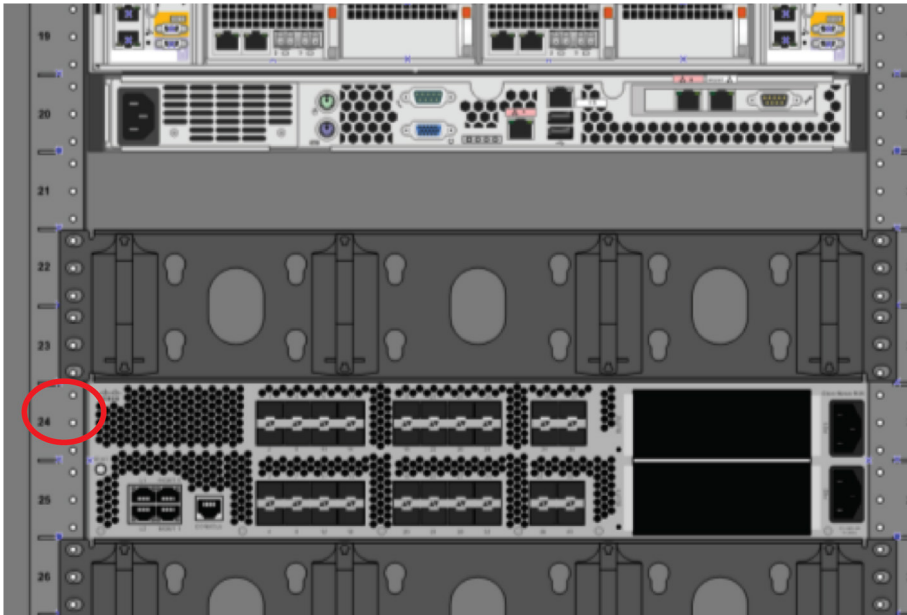

As an option, if there are dual sides in the equipment, the RU identifier can be modified to indicate the side.

For example:

C1-16A

Equipment Port Identifiers

The port identifier should have a format of:

s-a:b.n

Where

s = any object consuming floor space is labeled with the letters C for cabinet, R for rack, or M for mechanical device, plus a sequential number

a = location of equipment in the cabinet based on the RU position of the top-left corner of the equipment mounting flange

b = optional identifier to be used if the equipment has slots or cards added

n = one or two characters that correspond to the port number on the equipment back or slot or card. If there are connections for mixed media, then the port identifier should include either an E for Ethernet or F for Fibre Channel that precedes the port number.

Example:

R1-30:1.F4

This identifies the port as Fibre Channel connection 4 on card 1 in the equipment located at the RU 30 in rack R1, as shown in Figure 26.

Figure 26 - Identifying a port on a Cisco UCS I/O module



Example:

C3-28:2.F3

This identifies the port as Fibre Channel connection 3 on slot 2 in the equipment located at the RU 28 in cabinet C3, as shown in Figure 27.

Figure 27 - Uplink port on a Cisco UCS Fabric Interconnect



In addition, the following characters can be used to define ports:

CPn = Console port n

For example C1-24:CP1, as shown in Figure 28.

Figure 28 - Console port on a Cisco switch

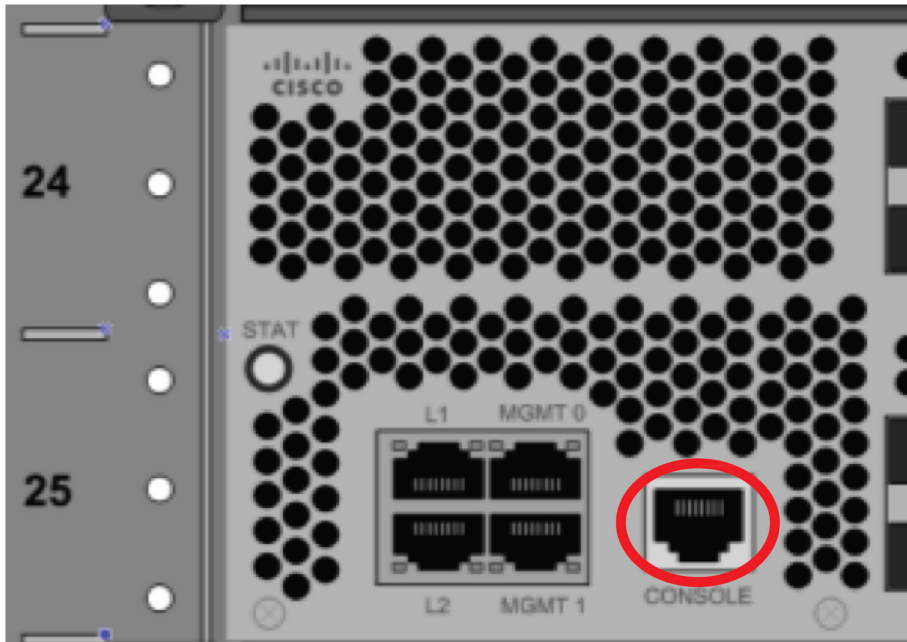

MPn = Management port n

For example:

C1-24:MP0

Cable Identifier

Cable labels should have a format of:

s1-a1:b1.n1/ s2-a2:b2.n2

Where

s1-a1:b1.n1 = the near-end equipment connection

s2-a2:b2.n2 = the far-end equipment connection

Cable labeling should be accomplished via machine printed labels. Labels should be affixed to both ends of the cable so that cables are connected in the appropriate ports.

For example:

C1-07:1.F1/R1-14:F1

This identifies the near-end connection Fibre Channel port 1 on slot 1 in the equipment located at RU 07 in cabinet C1 to the far-end connection Fibre Channel port 1 in the equipment located at RU 14 in rack R1.

Conclusion

This guide presents the mapping between the logical layer architectures in the Cisco SBA network core, including LAN and WAN aggregation, server room and security components and the *Cisco SBA—Data Center Deployment Guide* with Panduit Smart Data Center physical infrastructure solutions. By considering the logical and physical layers in a holistic manner, this design delivers on the design principles of ease of use, cost effectiveness, flexibility and scalability, and reusability. IT architects and engineers can use this guide in conjunction with the other documents in the Cisco SBA library to produce technical landscapes that are highly available, agile, and secure.

Notes

Appendix A: Sample Bill of Materials

| Part number | Description |
|---------------|--|
| C100X050A8T | Desktop Labeling System— Equipment Labels, Qty 1 per piece of equipment |
| C200X100YPC | Handheld Labeling System— Cabinet Labels, Qty 4 per cabinet |
| C300X100APT | Desktop Labeling System— Cabinet Labels, Qty 4 per cabinet |
| CLT150F-X4 | Slit Corrugated Loom Tubing |
| CPAF1BLY | Angled filler panel |
| CPAF2BLY | Angled filler panel |
| CPATCBL | Transitional cover for angled patch panels that occupies zero rack space |
| CTG3X8 | Cool Boot® Cabinet Top Air Sealing Fitting |
| FBC2X2YL | 2x2 FiberRunner® System QuikLock™ Coupler |
| FHDEC2X2YL | 2x2 Hinged Channel End Cap Fitting |
| FIDT2X2YL | 1-Port Spill-Out to 1.5" (38 mm) Inside Diameter Corrugated Tubing |
| FQZO-12-10 | 10Gig™50/125µm (OM4) MM SFQ Series MTP Cassette |
| FTRBN12 | Threaded rod bracket for Fiber-Duct system |
| FVTHD2X2YL | 2x2 Vertical Tee Fitting |
| FZE10-10M**Y | LC to LC 10Gig OM4 Multimode Duplex Patch Cord |
| GACB2 | Grounding Hanger Bracket for supporting grounding conductors from wire basket. |
| GB2B0306TPI-1 | Telecommunications Grounding Busbar (TGB). ¼" Thick x 2" Width x 12" Length. Tin-plated, copper bar with pre-configured isolators and mounting brackets. |

| Part number | Description |
|----------------|---|
| GJS660U | Equipment Jumper Kit for grounding Cisco equipment chassis. 6 AWG, green with yellow stripe, pre-connectorized at one end with a 2-hole copper compression lug. |
| HC2YL6 | 2x2 Snap-On Hinged Cover |
| HDW3/8-KT | 3/8" Stainless Steel Hardware Kit for attaching lugs to TGB. |
| HS2X2YL2NM | 2x2 FiberRunner® System Channel |
| LCC2-38DW-Q | 2-hole copper compression lug for attaching aisle ground to TGB. |
| LS8EQ-KIT | Handheld Labeling System— Printer, Qty 1 |
| NMF* | Horizontal cable mgr front only; * can be a number 1 – 4 for # RU spaces consumed |
| QAPP24BL | QuickNet™ Angled Patch Panel, 24 Port, 1 RU |
| QAPP48HDBL | QuickNet™ Angled Patch Panel, 48 Port, 1 RU |
| QARBCBCBXX** | QuickNet™ Cat6A Cable Assembly with pre-terminated jack module cassettes on each end (** = specify length in feet) |
| QCPBCBCBXX***N | Plenum, CAT 6A, cassette to cassette assembly (***) = specify length in feet) |
| QPP24BL | QuickNet™ Flat Patch Panel, 24 Port, 1 RU |
| QPP48HDBL | QuickNet™ Flat Patch Panel, 48 Port, 1 RU |
| QPPBBL | QuickNet™ Patch Panel Blank |
| R100X125V1C | Handheld Labeling System— Fiber Patch Cord Labels, Qty 2 per cord |
| R100X125V1T | Desktop Labeling System— Fiber Cable Labels, Qty 2 per cord |
| R100X150V1C | Handheld Labeling System— Copper Patch Cord Labels, Qty 2 per cord |
| R100X150V1T | Desktop Labeling System— Copper Cable Labels, Qty 2 per cord |
| R100X225V1C | Handheld Labeling System— Power Patch Cord Labels, Qty 2 per cord |
| R100X225V1T | Desktop Labeling System— Power Cable Labels, Qty 2 per cord |
| R4P4296 | 4 Post EIA rack with #12-24 threaded rails. |

| Part number | Description |
|----------------|--|
| RGCBNJ660P22 | Common Bonding Network (CBN) Kit for attaching racks and cabinets to the Aisle Ground. 6 AWG green with yellow stripe, pre-connectorized at one end with a two-hole compression lug and includes copper compression tap and mounting hardware. |
| RGS134-1Y | Grounding Strip Kit for Threaded Rails. Used for racks and cabinets with threaded hole equipment mounting rails. |
| RGS134B-1 | Grounding Strip Kit for Cage Nut Rails. Used for racks and cabinets with cage nut equipment mounting rails. |
| S752C122H | 45 RU x 700mm Wide Cabinet With Full Perforated Front Door, Split Perforated Rear Door, and Solid Side Panels |
| T050X000VXC-BK | Handheld Labeling System— Equipment Labels, Qty 1 per piece of equipment |
| TDP43MY | Desktop Labeling System— Printer, Qty 1 |
| TLBP1R-V | 1 RU Tool-less blanking panel for round tapped holes |
| TLBP1S-V | 1 RU Tool-less blanking panel for square holes with or without cage nuts |
| TLBP2R-V | 2 RU Tool-less blanking panel for round tapped holes |
| TLBP2S-V | 2 RU Tool-less blanking panel for square holes with or without cage nuts |
| UTP6A** | 10 G UTP Patch Cord (** = specify length in feet) |
| WG12BL10 | Wyr-Grid™ System 12" Wide Straight Section |
| WGBTMWFBL | Wyr-Grid™ System Bottom Waterfall |
| WGSDDL4BL | Wyr-Grid™ System 4" Sidewall |
| WGSPL1218BL | Wyr-Grid™ System Splice Connector for 12" and 18" Width |
| WGTB12BL | Wyr-Grid™ System 12" Wide Trapeze Bracket |
| WGWMTB12BL | Wyr-Grid™ System Wall Mount Termination Bracket |

Please see www.panduit.com for a complete listing of parts, products, and solutions.

Notes

About Panduit



Panduit is a world-class developer and provider of leading-edge solutions that help customers optimize the physical infrastructure through simplification, increased agility, and operational efficiency. Panduit's Unified Physical Infrastructure SM (UPI) based solutions give enterprises the capabilities to connect, manage, and automate communications, computing, power, control, and security systems for a smarter, unified business foundation. Panduit provides flexible, end-to-end solutions tailored by application and industry to drive performance, operational, and financial advantages. Panduit's global manufacturing, logistics, and e-commerce capabilities, along with a global network of distribution partners, help customers reduce supply-chain risk. Strong technology relationships with industry-leading systems vendors and an engaged partner ecosystem of consultants, integrators, and contractors, together with its global staff and unmatched service and support, make Panduit a valuable and trusted partner.

www.panduit.com cs@panduit.com 800-777-3300

Copyright and Trademark Information

NetApp, the NetApp logo, Go further, faster, Data ONTAP, FlexClone, FlexVol, NOW, RAID-DP, SnapManager, SnapMirror, Snapshot, and SnapVault are trademarks or registered trademarks of NetApp, Inc. in the U.S. and other countries.

Emerson Network Power is a trademark of Emerson Electric Co.

NOTE: The information contained herein is intended as a guide for use by persons having technical skill at their own discretion and risk. PANDUIT disclaims any liability arising from any information contained herein or for the absence of same.

Notes

Feedback

Click [here](#) to provide feedback to Cisco SBA.



SMART BUSINESS ARCHITECTURE

ALL DESIGNS, SPECIFICATIONS, STATEMENTS, INFORMATION, AND RECOMMENDATIONS (COLLECTIVELY, "DESIGNS") IN THIS MANUAL ARE PRESENTED "AS IS," WITH ALL FAULTS. CISCO AND ITS SUPPLIERS DISCLAIM ALL WARRANTIES, INCLUDING, WITHOUT LIMITATION, THE WARRANTY OF MERCHANTABILITY, FITNESS FOR A PARTICULAR PURPOSE AND NON-INFRINGEMENT OR ARISING FROM A COURSE OF DEALING, USAGE, OR TRADE PRACTICE. IN NO EVENT SHALL CISCO OR ITS SUPPLIERS BE LIABLE FOR ANY INDIRECT, SPECIAL, CONSEQUENTIAL, OR INCIDENTAL DAMAGES, INCLUDING, WITHOUT LIMITATION, LOST PROFITS OR LOSS OR DAMAGE TO DATA ARISING OUT OF THE USE OR INABILITY TO USE THE DESIGNS, EVEN IF CISCO OR ITS SUPPLIERS HAVE BEEN ADVISED OF THE POSSIBILITY OF SUCH DAMAGES. THE DESIGNS ARE SUBJECT TO CHANGE WITHOUT NOTICE. USERS ARE SOLELY RESPONSIBLE FOR THEIR APPLICATION OF THE DESIGNS. THE DESIGNS DO NOT CONSTITUTE THE TECHNICAL OR OTHER PROFESSIONAL ADVICE OF CISCO, ITS SUPPLIERS OR PARTNERS. USERS SHOULD CONSULT THEIR OWN TECHNICAL ADVISORS BEFORE IMPLEMENTING THE DESIGNS. RESULTS MAY VARY DEPENDING ON FACTORS NOT TESTED BY CISCO.

Any Internet Protocol (IP) addresses used in this document are not intended to be actual addresses. Any examples, command display output, and figures included in the document are shown for illustrative purposes only. Any use of actual IP addresses in illustrative content is unintentional and coincidental.

© 2012 Cisco Systems, Inc. All rights reserved.



Americas Headquarters
Cisco Systems, Inc.
San Jose, CA

Asia Pacific Headquarters
Cisco Systems (USA) Pte. Ltd.
Singapore

Europe Headquarters
Cisco Systems International BV Amsterdam,
The Netherlands

Cisco has more than 200 offices worldwide. Addresses, phone numbers, and fax numbers are listed on the Cisco Website at www.cisco.com/go/offices.

Cisco and the Cisco logo are trademarks or registered trademarks of Cisco and/or its affiliates in the U.S. and other countries. To view a list of Cisco trademarks, go to this URL: www.cisco.com/go/trademarks. Third-party trademarks mentioned are the property of their respective owners. The use of the word partner does not imply a partnership relationship between Cisco and any other company. (1110R)